

FACTORY AUTOMATION

# MITSUBISHI ELECTRIC INDUSTRIAL ROBOT FR Series





# Automating the World

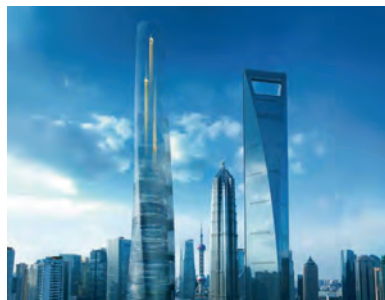

Our Factory Automation business is focused on "Automating the World" to make it a better, more sustainable environment supporting manufacturing and society, celebrating diversity and contributing towards an active and fulfilling role.

Mitsubishi Electric is involved in many areas including the following:

### **Energy and Electric Systems**

A wide range of power and electrical products from generators to large-scale displays.

### **Electronic Devices**

A wide portfolio of cutting-edge semiconductor devices for systems and products.

### **Home Appliance**

Dependable consumer products like air conditioners and home entertainment systems.

### **Information and Communication Systems**

Commercial and consumer-centric equipment, products and systems.

### **Industrial Automation Systems**

Maximizing productivity and efficiency with cutting-edge automation technology.



The Mitsubishi Electric Group is actively solving social issues, such as decarbonization and labor shortages, by providing production sites with energy-saving equipment and solutions that utilize automation systems, thereby helping towards a sustainable society.

# OVERVIEW



Product Lineup	7	<b>1</b>
Functions	11	<b>2</b>
Robot Specifications	35	<b>3</b>
Controller Specifications	53	<b>4</b>
Robot Option Specifications	55	<b>5</b>
System Configuration / Controller Option Specifications	59	<b>6</b>
Options	65	<b>7</b>
Technical Information	76	<b>8</b>

# The new future of automation made by next-generation intelligent robots



**Providing improvements in productivity, quality, environmental protection, safety and security to help reduce companies' TCO\* and boost their corporate value**

We offer solutions that use FA technology and IT to reduce total costs in everything from development through to production and maintenance, supporting customers to continuously improve their business operations and achieve truly cutting-edge manufacturing.

\*TCO: Total Cost of Ownership

## Seeing: Improvement

IT systems feed the results of analysis back into the production site

IT systems

## Observing: Analysis

Primary processing of data collected using FA (edge computing) Seamless integration with IT systems

Edge computing

## Watching: Visibility

Collecting production site data in real time

Production site

**Helping to increase corporate value through “Visibility<sup>3 (cubed)</sup> — seeing, observing, watching” and “Usability”**



**Introducing the next generation of intelligent robots, incorporating advanced solutions technology and “e-F@ctory”, technologies and concepts developed and proven using Mitsubishi Electric’s own production facilities that go beyond basic robotic performance to find ways of reducing the TCO in everything from planning and design through to operation and maintenance.**

# possible and e-F@ctory

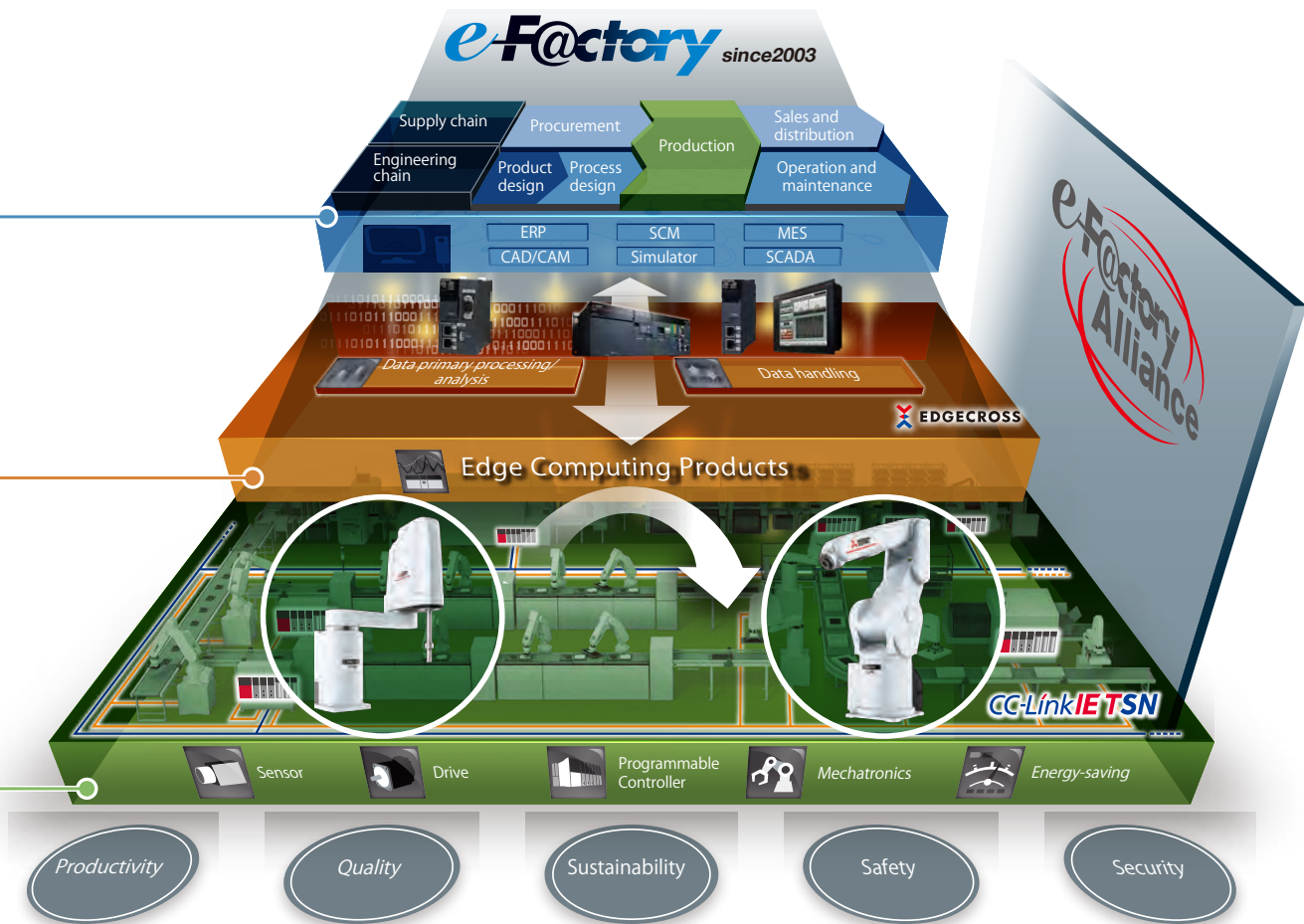

## MELFA



Cellular manufacturing



Assembly and Inspection



Parts supply

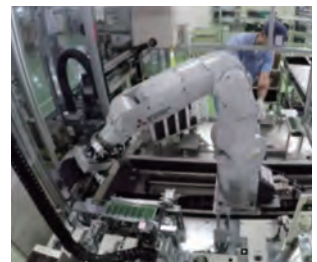

High mix production

# Evolved intelligence realizes advances in work procedures, cooperation between people and robots, and e-F@ctory-compatibility, making next-generation manufacturing a reality.

With globalization and increasingly diverse consumer needs in the market, the manufacturing industries face a time of considerable change. It is no longer enough for industrial robots to simply perform a single task. Industry now demands robots with the capacity and flexibility to readily take on more sophisticated tasks. The MELFA FR series provides new, more intelligent solutions that underpin "next-generation manufacturing", offering a simpler approach to advanced and flexible production. These robots can handle all your automation needs.

## MELFA FR Series

"Next-generation intelligent functions" make it simple to carry out work that has always defied automation. "Safe, collaborative work applications" allow robots and people to work together with high levels of safety. "FA-IT integration functions" support next-generation manufacturing. With these 3 key features, the FR Series is capable of handling virtually all your automation needs.

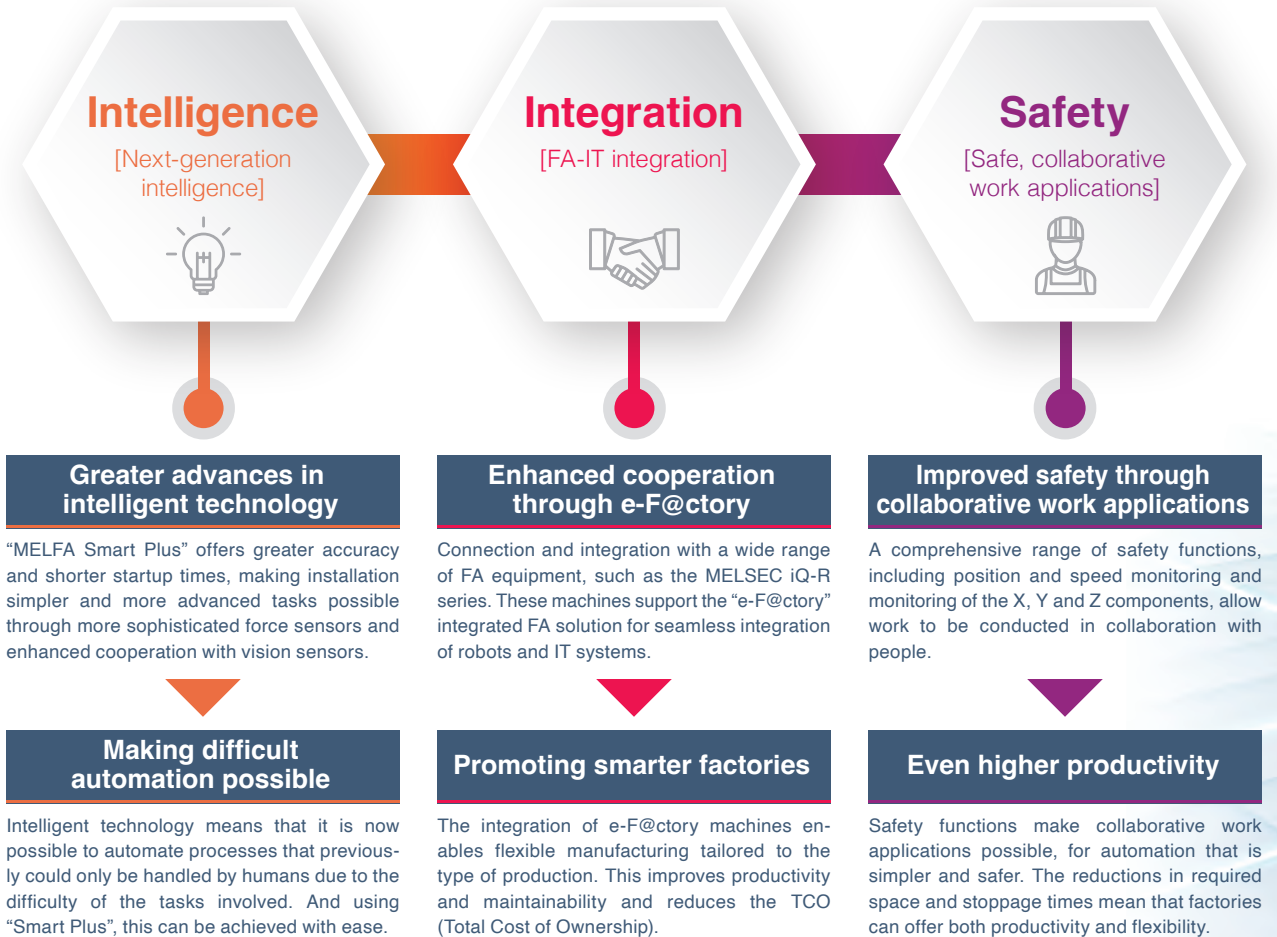

### MELFA Smart Plus

Function expansion options further broaden the range of possibilities of the MELFA FR series, offering performance beyond your expectations.



#### Integration with the MELSEC iQ-R series PLCs enables more advanced tasks!

Integrating these robots with the Mitsubishi Electric MELSEC iQ-R PLCs simplifies startup and improves productivity and maintainability, ensuring that you maximize the potential of the FR series.



 MITSUBISHI  
ELECTRIC

**MELFA** **FR**  
SERIES

## Vertical, multiple-joint type robots

# RV-FR SERIES

- Optimized arm length and 6 joints for a broader range of movement support complex assembly and process operations.
- Compact body and slender arms capable of covering a large work area and large load capacity.
- Suitable for a broad range of layouts, from transporting machine parts to assembling electrical components.
- Designed to withstand environmental conditions, making it ideal for a wide range of applications without having to worry about the installation environment.



### Vertical, multiple-joint type (RV) series

Type	RV-2FR	RV-2FRL	RV-4FR	RV-4FRL	RV-7FR	RV-7FRL	RV-7FRL	RV-7FRL	RV-13FR	RV-13FRL	RV-20FR	RV-35FR	RV-50FR	RV-80FR
Maximum load capacity	3kg		4kg		7kg				13kg		20kg	35kg	50kg	80kg
Maximum reach radius	504mm	649mm	515mm	649mm	713mm	908mm	1503mm	1094mm	1388mm	1094mm	2100mm			



## Horizontal, multiple-joint type robots

# RH-FR SERIES

- With a wealth of operating areas and variations, it is the perfect fit for a variety of applications.
- Highly rigid arms and cutting-edge servo controls provide superb precision and speed. Ideal for a wide range of fields, from high-volume production of foodstuffs and pharmaceuticals that demands fast operation, through to assembly work where high levels of precision are required.



### ■ Horizontal, multiple-joint type (RH) series

Type	RH-3FRH	RH-6FRH	RH-12FRH	RH-20FRH	RH-3FRHR
Maximum load capacity	3kg	6kg	12kg	20kg	3kg
Maximum reach radius	350mm 450mm 550mm	350mm 450mm 550mm	700mm 850mm 1000mm		350mm
Z stroke	150mm <sup>*1</sup>	200mm 340mm	350mm 450mm		150mm <sup>*2</sup>

\*1 Clean specification: 120mm

\*2 Clean and waterproof specification: 120mm

## Controller Types

# R/Q TYPE Controller

This controller is compatible with the “iQ Platform”, which seamlessly integrates the various controllers used in a production site with HMI, the engineering environment and the network. It uses a multi-CPU configuration that dramatically improves its interaction with FA equipment and also offers highly precise control and fast yet simple information management.

### [R TYPE controller]

MELSEC iQ-R series-dedicated

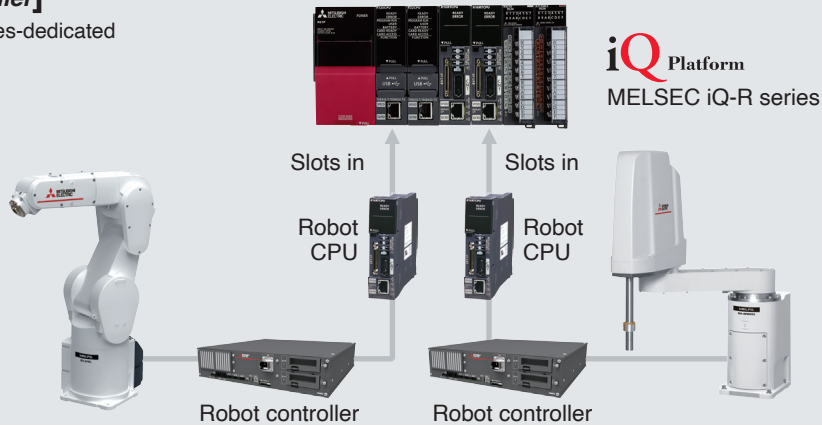

### [Q TYPE controller]

MELSEC Q series-dedicated

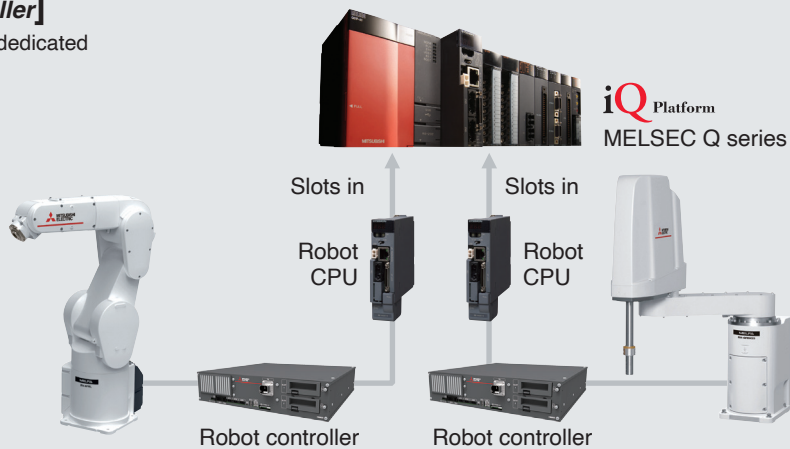

# D TYPE Controller

A standalone controller similar to existing models. Enables the construction of cells using robot controllers as the control nucleus. Comes with various interfaces as standard, allowing customers to build a system optimized for their applications.

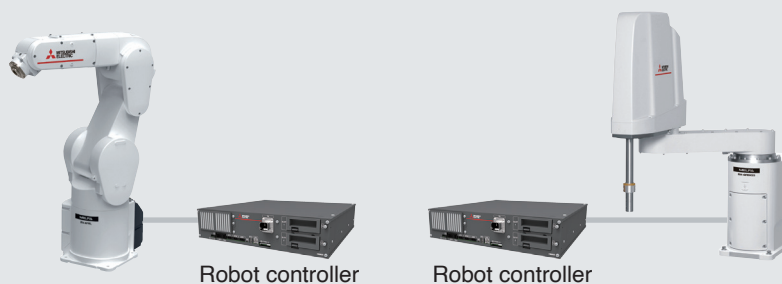

**Basic performance**

**Improved controller performance**

Control cycles on FR series controllers take just half the current time, improving robot control performance. The faster calculation speed gives better robot processing capacity and shorter cycle times for improved productivity. Integration with the various sensors also makes precision operation possible. (The performance of FR series Q type controller is equivalent to F series Q type controller.)



The R Type controllers supported by the MELSEC iQ-R series dramatically improve compatibility with FA equipment, allowing information to be shared mutually and data to be collected and processed. Improved system bus performance has also reduced communication cycles to 1/4 of current levels, allowing shorter cycle times for production facilities.

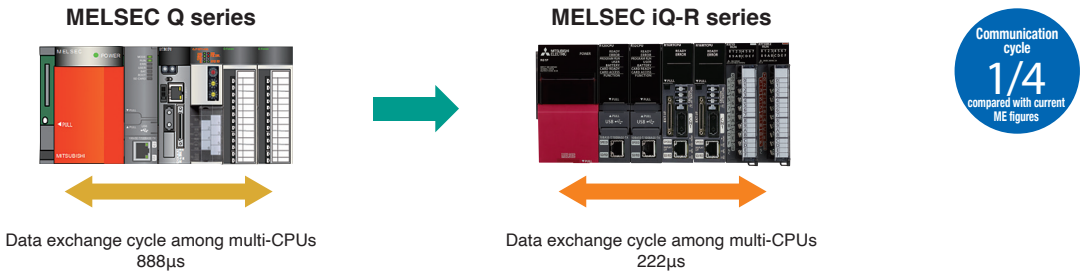

**Dedicated motors for high-speed operation**

Using motors developed in-house, highly rigid arms and our original drive control technology, these machines are capable of high-torque output at high rotation speeds, giving better operating performance. Their capacity for continuous operation is also improved, with higher productivity due to the shorter cycle times.

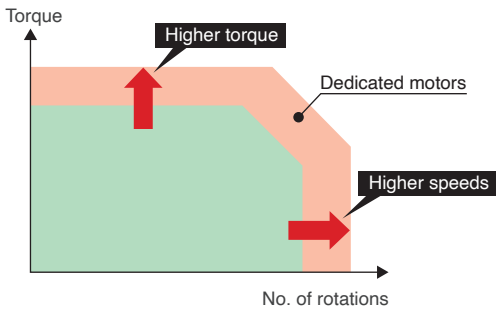

**Expanded pivotal operating range**

Improved flexibility for robot layout design considerations. Enabling more effective use of access space around the entire perimeter including to the rear. Shortened movement distances, enabling cycle times to be shortened.

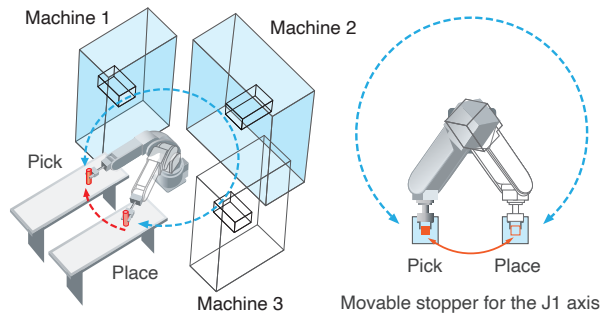

**Preventing cable interference**

Internal wiring channels provided in the tip axis. Allows wiring and tubes to be routed internally up to the gripper mount. By routing the body cables internally, areas where body cables might interfere with peripheral equipment can be minimized and the problem of wiring and tube tangles can be eliminated.

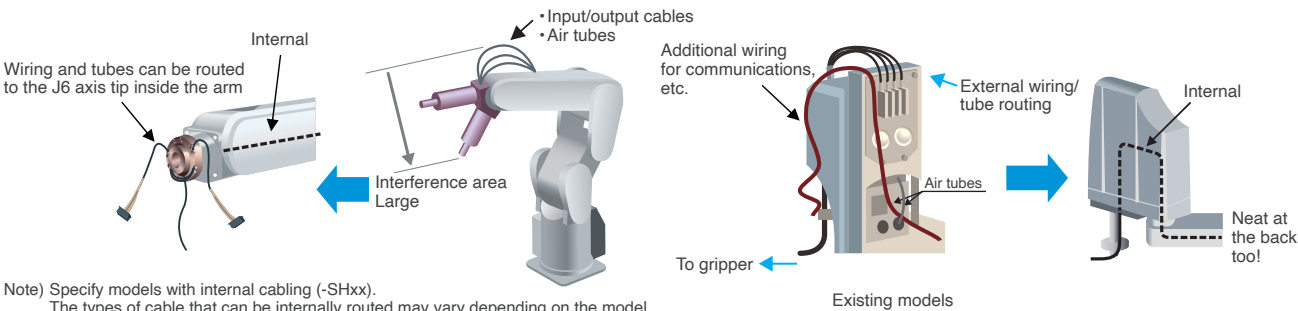

Note) Specify models with internal cabling (-SHxx).  
The types of cable that can be internally routed may vary depending on the model.



# Greater advances in intelligent technology

Enhanced cooperation with vision sensors and more advanced force sensors allow more advanced tasks to be accomplished at higher speeds and with greater precision.

Through the use of highly accurate vision sensors and force sensors that control the levels of force applied by robots, it is now possible to automate extremely difficult tasks that have been beyond the scope of automation in the past.

2

Functions

## Force sensor

- Checks the applied force and the force status during insertion to provide improved work quality
- Assembly of difficult-to-fit workpieces
- Teaching assistance using force information
- Faster control cycles for improved force control

## 3D vision sensor

- Kitting or sorting of irregularly placed or overlapping workpieces
- Supports functions for easier startup

## Preventing interference

### iQ Platform

Checking for interference between the arms and grippers of adjacent robots prevents any contact.

## 2D vision sensor

- Setup tools for vision simplify the calibration of robots and cameras
- Simple Ethernet connections between robots and cameras
- Easy control using vision control instructions in the robot programs

## Cooperative control

### iQ Platform

- Two robots can be coordinated to transport very long or heavy objects
- Positional relationships of non-fixed parts maintained during transportation and assembly

## Multi-function gripper

- Multi-function electric grippers capable of working with different part types of varying sizes
- Less need for setup changes

## Example of intelligent technology use

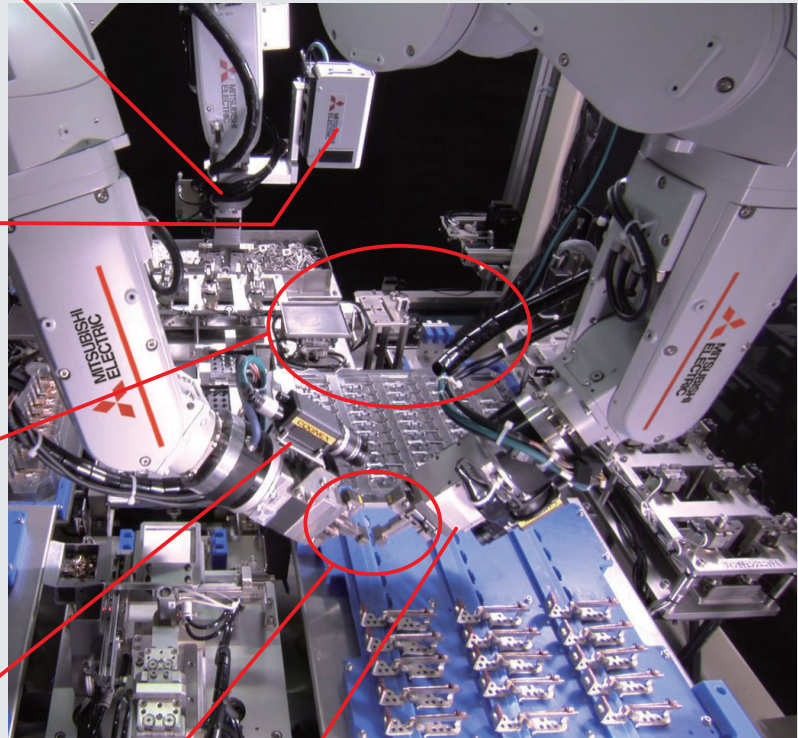

## Tracking

Transport, alignment, and assembly work, etc. can be performed while robots are tracked with the workpiece on the conveyor without stopping the conveyor

## Tracking accuracy enhancement function

Positional gain is changed in real time for even better tracking accuracy

## Other functions

Singular point transit and orthogonal compliance functions facilitate the completion of a range of different tasks.



MELFA Smart Plus supports cell production, using robots to overcome the limitations on lead times, production volumes, and location.

# MELFA Smart Plus

## MELFA Smart Plus

Advanced features such as integration functions for the various sensors and autonomous startup adjustment functions are provided for all phases of customer's operations, from design and startup through to operation and maintenance.

\*Activated with the insertion of a Smart Plus card

### CR800 Controller



MELFA Smart Plus card (2F-DQ5XX)



### Predictive maintenance function

Quickly detects abnormalities in drive system components before they affect robot behavior.

### Preventive maintenance function

Maintains the robot's health with operation status tracking

### Enhancement function for force sense control

Parameters for the optimum operation pattern are found using repeat learning in a short amount of time. Set0up and tact times are reduced.

### 2D vision sensor enhancement function

Achieve robot automation "easily for anyone" using a variety of vision applications!

### MELFA-3D Vision enhancement function

Reduced startup time thanks to automatic parameter adjustment which utilize our proprietary AI technology "Maisart".

### Coordinated control of additional axes

Using a robot with an RTU enables manufacturing and assembly at user specified speeds.  
\*RTU: Robot Transport Units

### Robot mechanism thermal compensation function

Compensates for thermal expansion of the robot arm to increase position accuracy.

## Calibration assistance function

### Automatic calibration

Improves positioning accuracy by automatically correcting the vision sensor coordinates.

### Work coordinate calibration

Improves positioning accuracy by automatically correcting the robot coordinates and work coordinates from the vision sensor.

### Relative position calibration

Uses vision sensors to automatically adjust the robot location relative to other robots. Improves positioning accuracy during coordinated operation.

The high-precision technologies and calibration functions provided by MELFA Smart Plus allow correction of machine deviations between cells, offline teaching, and copy cells\*1. This then enables coordinated operation between the master cell and other cells.

\*1 Offline teaching: Operation where programs created in a simulation are transferred to an actual cell for operation.  
Copy cell: Conveys master cell modification information. Processes in cells in other locations are then modified in the same way.

Preventive Maintenance screen (RT Toolbox3)

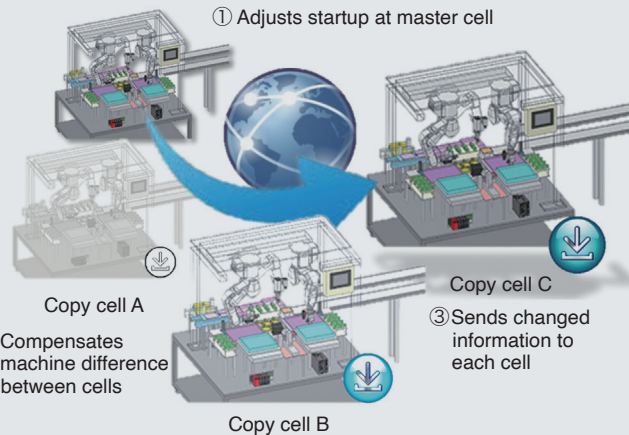
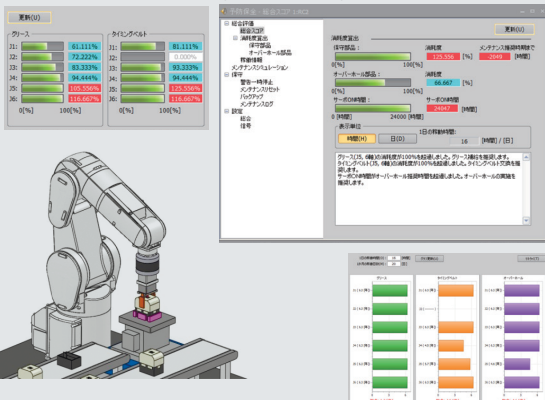



# Greater advances in intelligent technology

## Force sensor

See P.67 for detailed specifications →

Monitors the force applied to the robot gripper so that copying and fitting work can be carried out as it would by a human operator.

### Force control

Controls “force” and “flexibility”.  
Modifies control properties during operation.

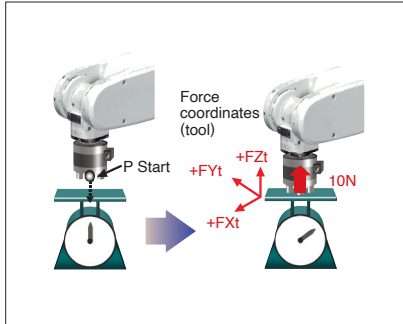

Keeps the force constant so that the workpiece can be handled without causing damage

### Force detection

Switches operation in response to transitional states.

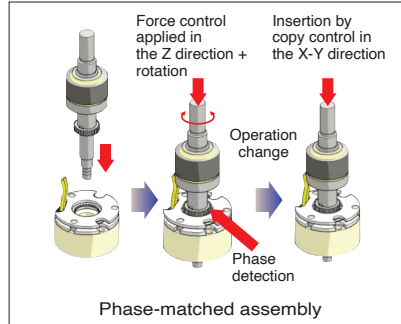

Complex assembly tasks achieved through techniques such as phase matching

### Force log

Checks the work status.  
Saves log data.

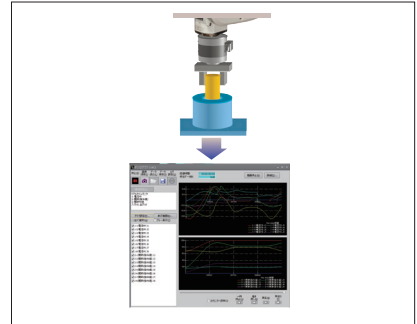

Checks the work status to facilitate adjustment.  
Log data analysis also allows predictive safety measures

2

Functions

## More accurate force sensor

Advances in force sensors allow faster and more accurate testing.

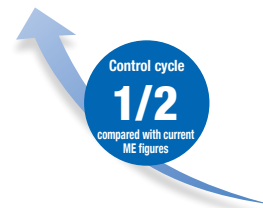

## Gravitational offset cancellation

Compensates for gravity in response to changes in force on the force sensor in the X, Y and Z directions when the attitude changes.

Force control can be exercised correctly even when the attitude changes.

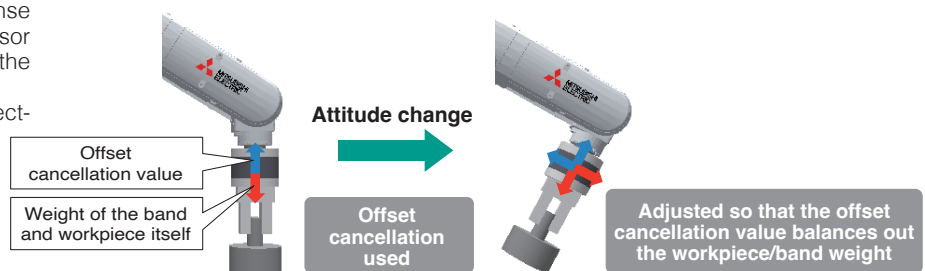

## Teaching work assistance

### Force GUI included\*\*1

- Computer software (RT ToolBox3) and a teaching box (R86TB or R32TB) are standard features of the force GUI screen, making it easy to use force sensors.
- Teaching can be carried out while monitoring the reactive force on the force GUI screen.

\*1 GUI: Graphical User Interface

- Force data synchronized to the positional data can be saved as log data.
- Log data can be viewed as graphs using RT ToolBox.
- Log data files can be downloaded to a computer via FTP.

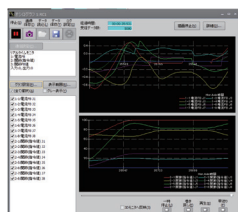

■ Force log (RT ToolBox3 log viewer)



R32TB

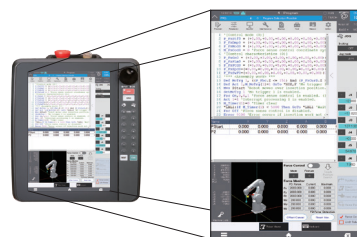

R86TB

Teaching while monitoring force states using the dedicated force control screen in the teaching box. Enables optimized location teaching

Enhancement function for force sense control

MELFA Smart Plus

AI automatically adjusts to the optimum parameters for force sensing. The optimum parameter calculation function allows anyone to easily adjust to the optimum parameters in a short time. This allows shorter system startup and tact time.

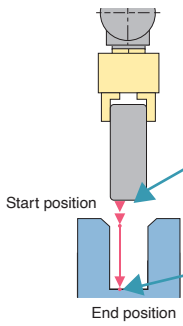
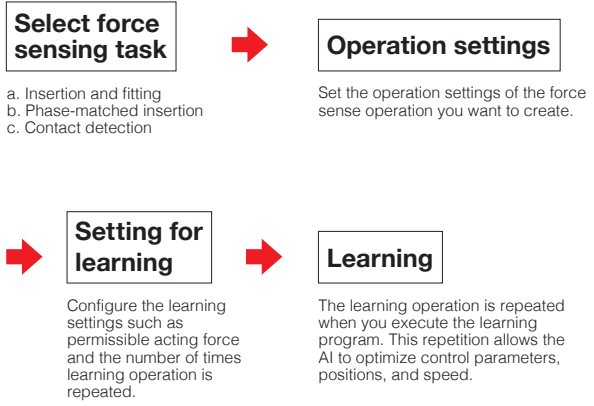
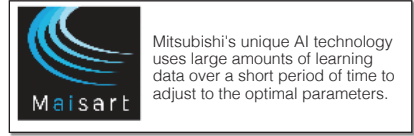

Assembly work (case study)

Fitting a coupling onto a spindle (insertion task with H7h7 tolerance)

Key Points!

- Insertion is by fitting along the Z axis in the soft state while rotating in the  $\theta$  axis direction.
- Force is specified where both are aligned on the same axis.
- Once they are aligned on the same axis, operation switches to positional control mode and the parts are assembled into their installed positions.
- The parameters required for this work can be set freely.

Operation overview

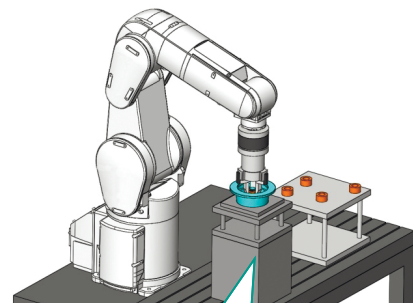
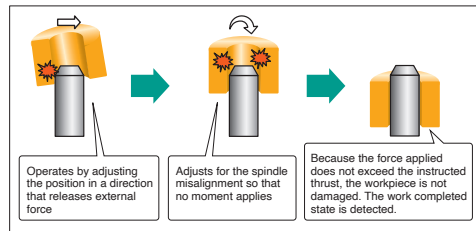

Related case studies

**D-cut part insertion work**

Fit while rotating

Insert to assemble by matching the gear phase to the D-cut spindle (10mm dia.)

**Gear assembly work**

Assembly by meshing a flat gear and pinion gear

**Bearing insertion work**

Insertion of bearing

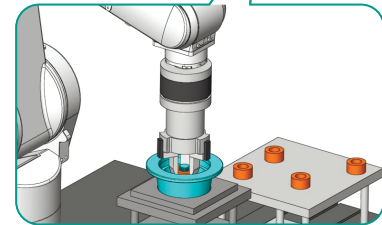

Force inspection (case study)

Fitting of a part where the force must be managed and the spring pressure inspected

Key Points!

- The fitting assembly and spring pressure inspection are carried out on one machine.
- Force is inspected at the fitting operation stop position.
- The spring pressure is inspected in the force log.
- Productivity is improved due to assembly reliability and automatic testing.

Spring pressure inspection waveform

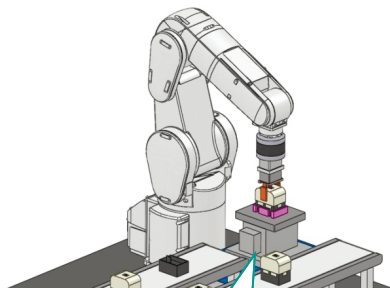
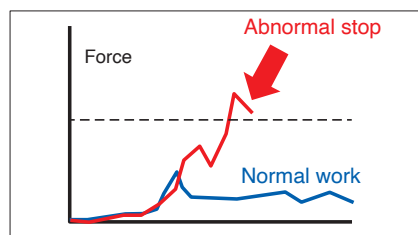

Related case studies

**Spindle size inspection**

A spindle workpiece is inserted into a gauge to inspect the size

**Snap mechanism part assembly work**

Measures variations in the pressure on the snap mechanism part and assembles the part with the correct force

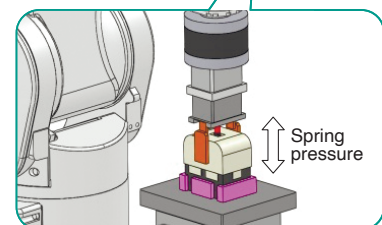



# Greater advances in intelligent technology

2

Functions

## 3D vision sensor MELFA-3D Vision 3.0

**NEW**

See P.76 for detailed specifications.

### Enables bulk feeding

The ability to perform bulk feeding without the use of special trays or parts feeders makes part feeding much easier.

### High-speed picking using original technology

Shortens the image recognition time with high-speed recognition technology. (30% increase compared to our conventional model) Either the model-less recognition, which enables high-speed picking or the model-matching recognition method, which accurately matches the workpiece position and orientation, can be selected to suit the application.

### Automatic parameter setting with AI

Mitsubishi's original AI technology and simulation technology automate the sensor parameter adjustment work, which requires expert knowledge. Anyone can easily achieve the same performance as a skilled worker in a short time without needing an actual machine. (Compatible only with model-less recognition)

### Lightweight and compact for diverse installation

Compatible with ENSENDO N35 series cameras. The extensive lineup of compact and lightweight models enables a flexible system configuration.

### Automatic calibration function **NEW**

Equipped with an automatic calibration function that automatically aligns the robot and vision sensor. This makes adjustments much easier.

### Workpiece supply assistance function

Spindle characteristic mode and orientation output mode can be used to ensure a stable grip during model-less recognition. The function to estimate the remaining bulk workpiece level allows the operator to understand the timing to load supplied parts.

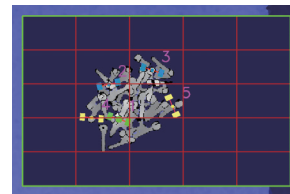
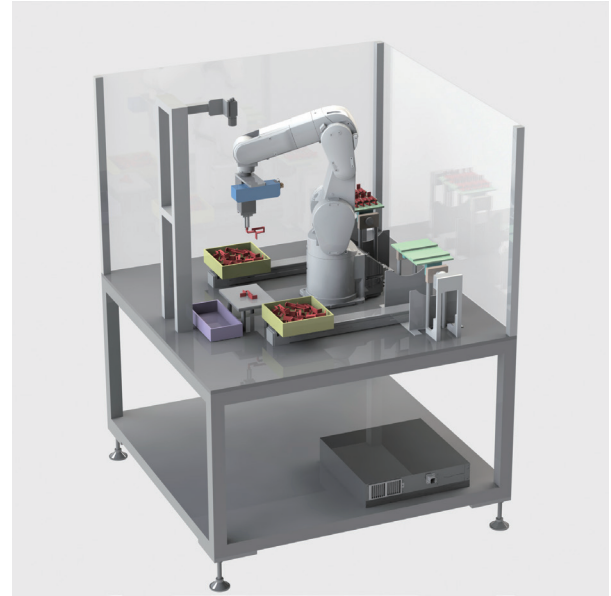

Model-less recognition

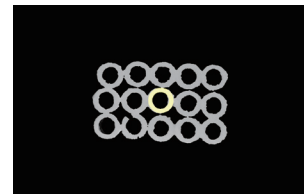

Model-matching recognition

### Lightweight, compact, with a wide field of view

Smaller and more lightweight, equipped with ENSENDO camera head. Both hand-eye and fixed installation are available. Additionally, the camera itself supports oil mist environments (IP65/IP67), and increased workpiece distance and visual field allow for broader application. It flexibly supports everything from precision assembly of small parts to bulk picking from large pallets.

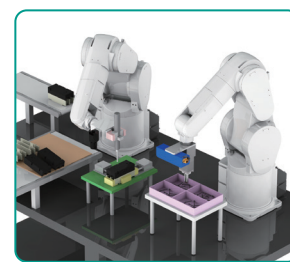

Small part assembly (Hand-eye)



Picking from a large pallet (Fixed camera)

### Automatic parameter setting with AI

AI automatically adjusts the optimum 3D sensor parameters (image processing parameters, grip position recognition parameters) in a virtual space. (See P.68 for compatible cameras.) Adjustment of complicated parameters is simplified by using the 3D CAD data, even without the camera head. This greatly reduces the vision sensor parameter adjustment time.

#### Features

- AI automatically adjusts parameters on the PC.
- No need for expertise knowledge.

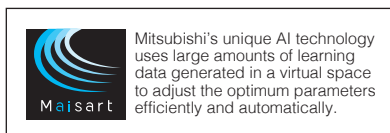

3D information on partst

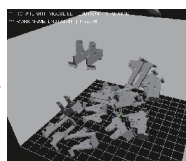

Bulk parts supply state is reproduced with physical simulation



3D sensor simulation repeats parts measurement and recognition



AI automatically adjusts sensor parameters



**Multi-function electric gripper**

See P.79 for detailed specifications →

**High-functioning operation control not possible using air cylinders**

The gripping force and speed can be specified to suit the target, whether it's a heavy object or involves delicate work. Even when handling multiple workpieces of varying sizes, the operating positions can be specified so that the optimum stroke is configured. Product inspections can be informed by positional feedback from the gripper, such as whether gripping was successful or whether workpiece measurements indicate that it is acceptable.



● Multi-function electric gripper (TAIYO)

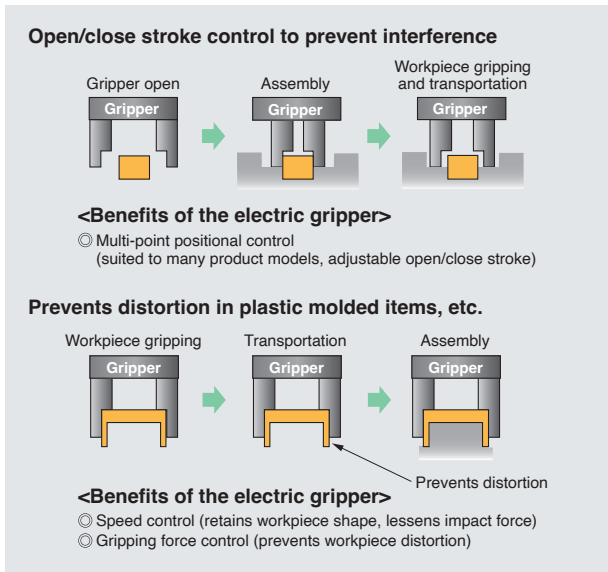

**Simple control**

The operation stroke and grip force can easily be configured for the workpiece shape using the robot programming.

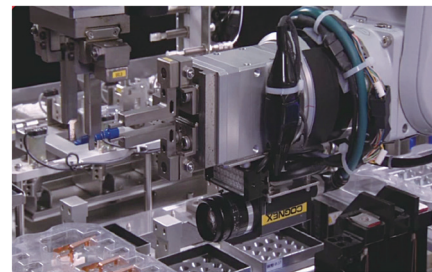

**Easy operation**

The gripper can be freely controlled from the dedicated gripper screen in the teaching box.

**Interference prevention function**



**Automatically prevents collisions between robots**

Unanticipated interference can be prevented during jogging or automatic operation because collisions between robots are detected in advance and robot movement is stopped.

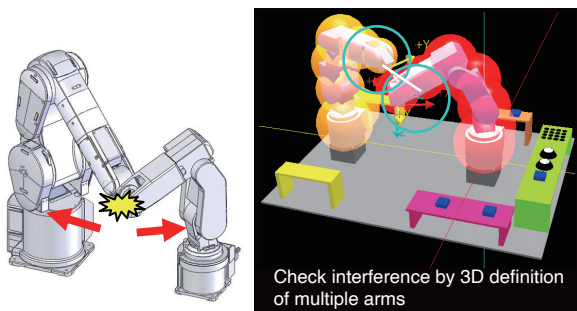

**Reduced workload during startup**

The number of recovery processes following collisions due to missed interlocks or teaching errors can be reduced.

**Cooperative control**



**Cooperative control using multiple arms**

Cooperative control between multiple robots is enabled through CPU connection between the robots. Normal operation is through individual robot operation, making operation simple.

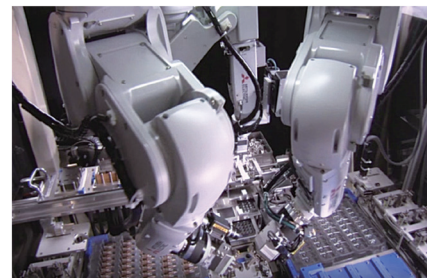

Assembly work that maintains the relative positions for mutual gripping

**Coordinated transportation**

Long or flexible objects can be transported using multiple small robots instead of larger robots.



# Greater advances in intelligent technology

2

Functions

## Tracking

- Transport, alignment, and installation work, etc. can be performed while a robot is tracking workpieces on the conveyor without stopping the conveyor.
  - Different variations can be selected, including vision tracking in combination with a vision sensor, tracking in combination with an opto-electronic sensor, etc.
  - Programs can be created easily in robot language (MELFA BASIC).
  - Standard interface function. (Separate encoder and vision sensor required.)
- No need for a positioning device
  - Reduce cycle time
  - Reduce system costs

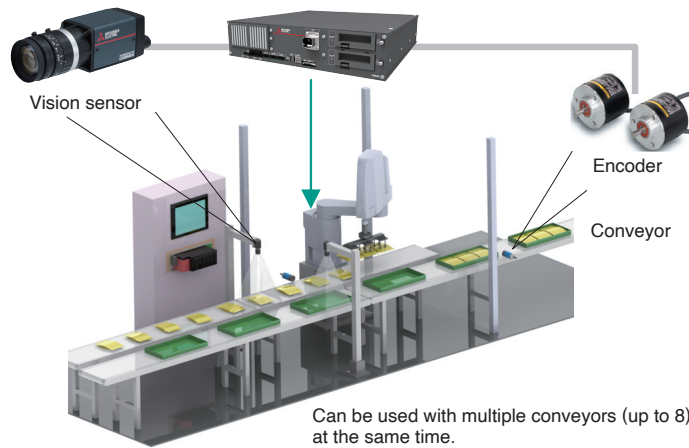

## Additional axis function

- The layout can be set up to include the robot traveling axis and turntable as well as user machines separate from the robot such as loaders and positioning devices.
  - Up to 8 additional axes can be controlled excluding the robot.
  - Additional axes and user machines can be operated from the robot teaching pendant without any additional motion control hardware. The same JOG operation as for the robot can be used. Robot language can be used for control operations.
  - The robot controller has compatibility with the MELSERVO (MR-J4-B, MR-J3-BS) servos.
  - Standard interface function (Separate servo amplifier and servo motor required.)
- No need for a dedicated control device

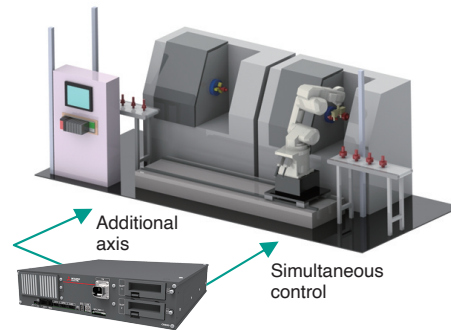
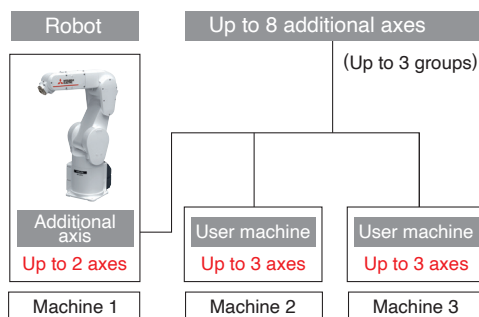

## Improved accuracy

### Active gain control

- Optimal motor control tuning set automatically based on robot operating position, posture, and load conditions.
- Improves tracking accuracy for the target trajectory.

- Active gain control is a control method that allows the position gain to be changed in real time.
- This is effective when traveling straight and sealing work requiring high accuracy.

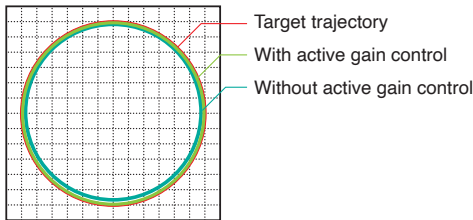

### Operating mode setting function

- Trajectory priority mode/speed priority operation can be set in programs to match customer system requirements.
- Optimal motor control tuning set automatically based on robot operating position, posture, and load conditions.
- Improves tracking accuracy for the target trajectory.
- This is effective when traveling straight and sealing work requiring high accuracy.

- Improve trajectory accuracy
- Improve vibration-damping performance

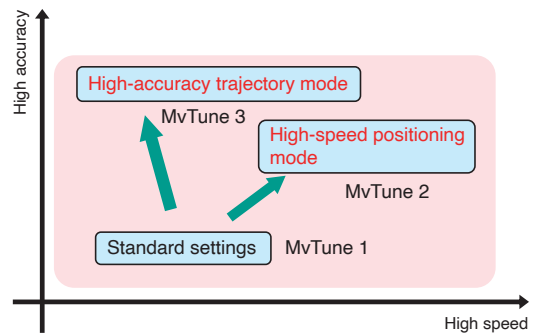

## Other functions

### Collision detection function

- This function detects robot arm collisions during teaching or operation which minimizes damage to the robot body and the grippers.
- The collision detection function can be used to protect the workpiece from becoming damaged due to interference between the workpiece and affected objects.
- The detection level can be changed according to the protection targets.
- Operation following collision detection can be programmed to suit the circumstances. Example: Stop immediately and post an error; retract and then post an error, etc.

- Reduce tooling costs
- Shorten downtime
- Reduce maintenance costs

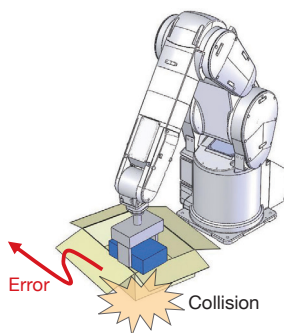

### Function for passing through the singular point

- The robot can be made to pass through the singular point. This allows for greater flexibility in the layout of robots and surrounding areas.
- Teaching operations can be performed more easily as there is no longer any need to cancel operations due to the presence of the singular point.

#### What a singular point is:

There is an unlimited number of angles at which the J4 and J6 axes can be set such that the angle of the J5 axis is 0° when linear interpolation operations are performed using position data from a joint coordinate system. This point is the singular point and is the point at which the robot cannot be operated at an assigned position and posture under normal conditions. The position at which this occurs is referred to as a singular point.

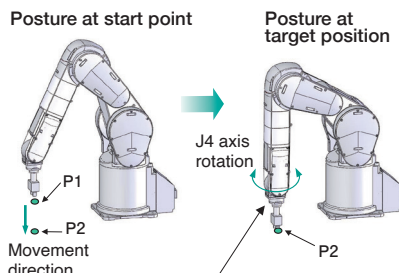

In moving from P1 → P2, if the robot is passing the singular point (J5 axis = 0°) or a location in the vicinity at a constant posture, the J4 axis on the robot will rotate at high speed and be unable to pass through it.

### Orthogonal compliance control

- This function reduces the rigidity of the robot arm and tracks external forces. The robot itself is equipped with a compliance function, which makes special grippers and sensors unnecessary.
- This allows the amount of force generated through interference during chucking and workpiece insertion to be reduced and external movement copying forces to be controlled.
- The compliance direction can be set arbitrarily using the robot coordinate system, the tool coordinate system, etc.
- This is useful in protecting against workpiece interference and cutting down on stoppage.

- Reduce tooling costs
- Shorten line stop times
- Shorten startup times

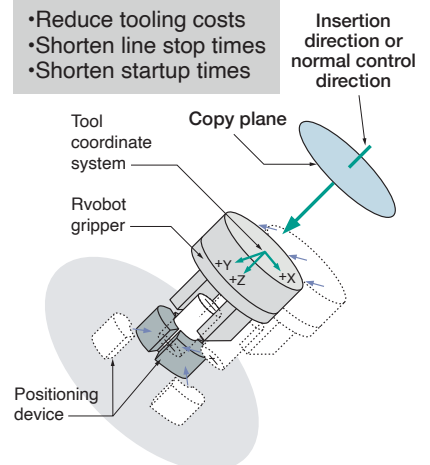



# Greater advances in intelligent technology

## Predictive maintenance function



### ■ Fault detection function

Mitsubishi's unique technology can detect signs of failure. This enables maintenance to be performed before a serious failure and reduces downtime.

**Applicable parts** :Reduction gears, encoders, batteries

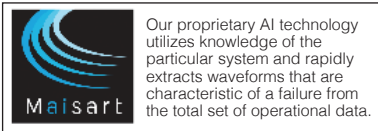

#### Features

- Able to detect early signs of a failure**  
Our unique fault detection technology allows quick detection of abnormalities in drive system components before they have a chance to affect robot behavior.
- No need for additional sensors or equipment**  
The robot controller is equipped with special fault detection AI processing that significantly reduces the number of required calculations by utilizing the knowledge of the particular system. This allows highly sensitive fault detection using only the existing controller without the need to add any analysis devices or sensors.

## Preventive maintenance function



### ■ Maintenance simulation

This can be used to estimate the maintenance component replacement and component overhaul maintenance timings. This estimated information can be used to review the maintenance cycle beforehand and to verify operation to extend the service life of the robot.

#### Output data

Grease replenishment period (per axis) / Timing belt replacement period (per axis) / Recommended maintenance period for overhaulable parts (per axis)\*1  
\*1 Among overhaulable parts such as reduction gears, bearings, ball screws, and ball splines, the part which needs to be overhauled the earliest will be displayed.

#### Features

- Estimates the maintenance period according to operating conditions**  
It is possible to calculate the parts replacement and recommended maintenance periods when a specific operation pattern (robot program) is repeated.
- Supports the investigation of robot-friendly operation**  
**It is possible to estimate the service life of the robot through an offline simulation.**  
It is possible to verify operation while considering tact time and service life even when changing operation programs.

### ■ Wear calculation function

This function estimates the degree of wear of components from the robot operating status. It aids the implementation of efficient maintenance practices by providing maintenance timing notifications (with dedicated signal outputs, warning outputs), and by deciding the maintenance priority, etc.

**Applicable parts** :Consumable parts(grease,timing belts,etc.),overhaulable parts(reduction gears,bearings,ball screws,ball splines)

#### Features

- Allows you to understand the degree of wear for major components**  
Allows you to use a dynamic model and drive data to calculate physical quantities such as velocity and forces acting on a component.It is possible to calculate the degree of wear for each part using its service live formula.
- Appropriate maintenance period notifications**  
The system can issue a warning or output a signal to notify the user that maintenance is required.

## Total score

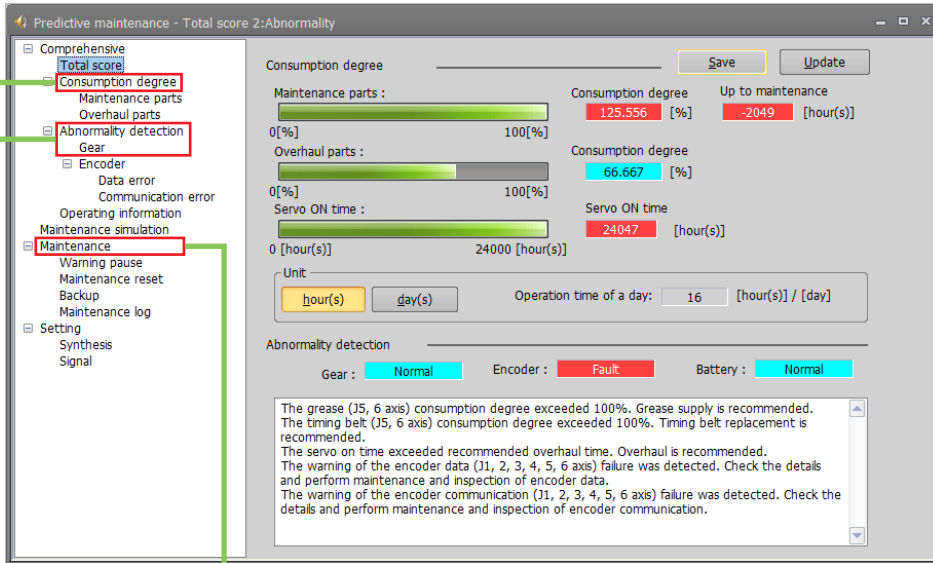

The total score screen allows you to check the state of the robot at a single glance.

## Wear calculation function

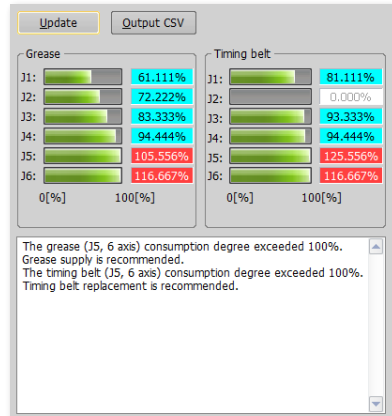

The degree of wear of maintenance components and overhaul components is color-coded, so components needing replacement can be quickly identified.

## Maintenance simulation

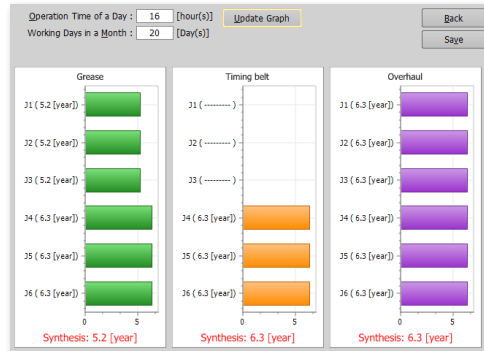

The maintenance period can be predicted in advance through simulation.

## Fault detection

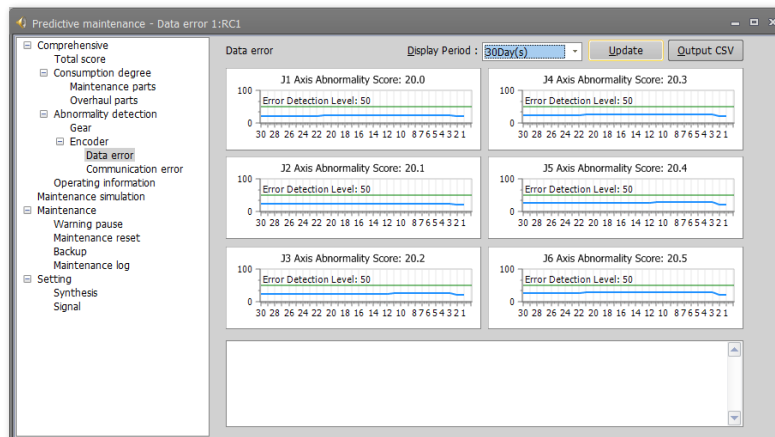

Allows you to view the fault score of the drive system components at a glance.



# Greater advances in intelligent technology

## Calibration assistance function

### Automatic calibration

Commands for calibrating the robot and 2D vision are included. This automates the teaching work required for existing calibration and allows calibration to be conducted using robot programs. A function is also provided that uses screen deviation to compensate for vision sensor mounting error, ensuring more accurate calibration.

MELFA Smart Plus

	Current method (manual)	Automatic calibration
Working time (minutes)	20	1
Calibration accuracy (mm)	±0.2	±0.05

(Mitsubishi Electric measurements)

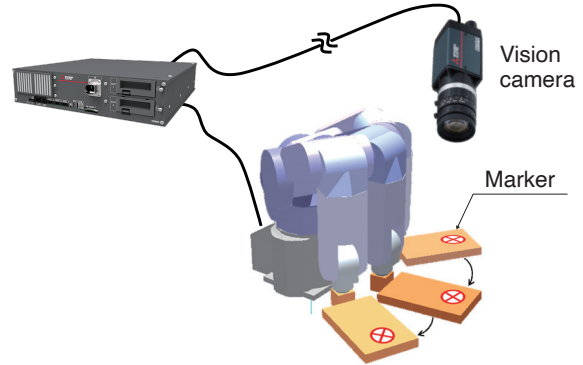

2

Functions

### Workpiece coordinate calibration

Features 2D vision sensors mounted on the robot gripper and commands that calibrate work coordinates defined on the work palette, automating the teaching work required for existing calibration and allowing calibration to be conducted using robot programs. This simplifies tasks such the calibration of work palettes and robots installed on dollies or automated guided vehicles (AGVs).

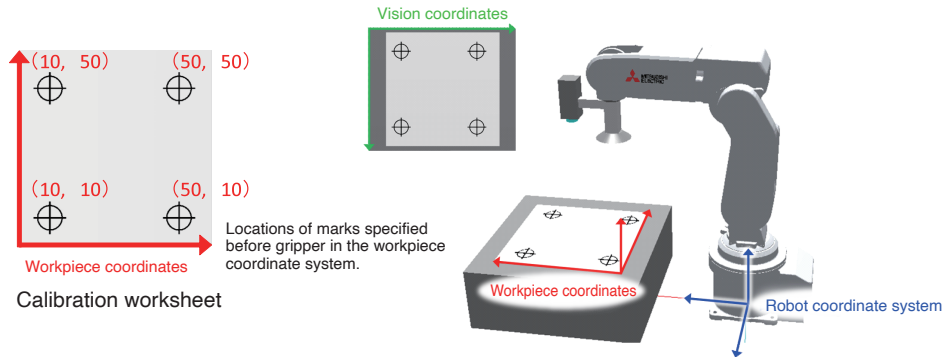

### Inter-robot relational calibration

Coordinated work can be simplified by running robot programs to calibrate workpiece coordinates that are shared among multiple robots fitted with 2D vision sensors on their grippers.





# Greater advances in intelligent technology

## 2D vision sensor enhancement function

MELFA  
**Smart Plus**

### Supports a variety of vision alignments

- Covers practical solutions such as simple pick and place work and grip misalignment correction
- Supports multi-product workpiece (up to 5 types can be registered)

<b>Basic Application</b>	Recognition with a fixed camera 	Recognition with a hand camera 	Grip deviation correction with fixed camera (upward camera) 	Grip deviation correction with fixed camera (Landscape Camera) 	-
<b>Advanced Application</b>	Workpiece recognition with the hand camera in the palette 	Grip deviation correction by recognizing workpiece in the palette 	Position and grip deviation correction 1 (for small workpiece) 	Position and grip deviation correction 2 (for medium workpiece) 	Position and grip deviation correction 3 (for large workpiece) 

You can choose from nine applications, and when you do, you can check the operation image with animation.

### Easy startup by intuitive operation

- Vision robot settings and operation programs are automatically generated only by setting according to the guidance.

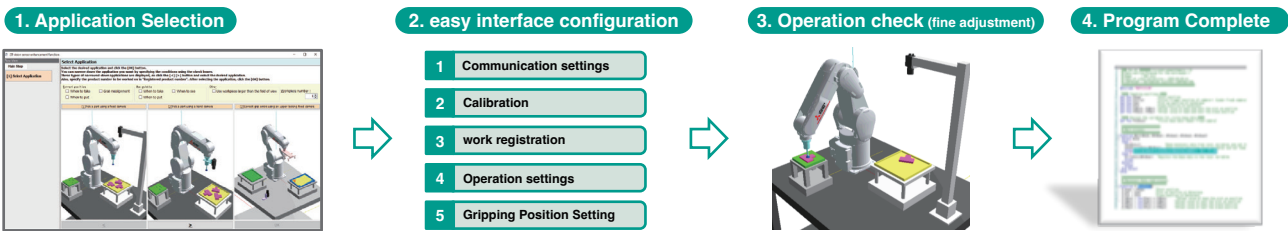

When using the MELSENSOR series and Cognex vision sensors, the series of task is completed within RT ToolBox 3. No other software is required.

<b>Supported models</b>	<b>Mitsubishi Electric: MELSENSOR VS 70/80 Series</b> <b>Cognex: In-Sight 7000/8000</b>
-------------------------	--

### scalable program

- Programs can be customized based on the created program.

For the vision/robot settings and operation programs that are automatically generated according to the guidance, you can add or change programs according to your system, such as interlocking with peripheral devices and adding operation path points to avoid interference.

	Classification	Contents
1	vision imaging process	Control the imaging timing. <sup>(*)</sup> Example) Interlock with peripherals
2		Add an operation path to the vision imaging position. Example) Avoidance of interference with peripheral devices
3	pick-and-place processing	Control the timing during transport operation. Example) Interlock with peripheral device
4		Correct the operation path. <sup>(*)</sup> Example) Avoidance of interference with peripheral devices
5	error handling	Change the error handling. <sup>(*)</sup> Example) Notification and recovery of abnormal status

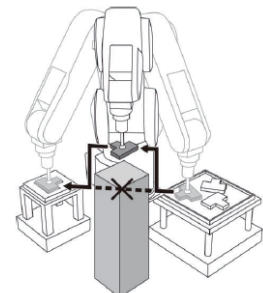

Example) Added an operation path when moving from the position to take to the position to put.

※ Examples of program additions and changes are provided in the manual.



# Greater advances in intelligent technology

## Coordinated control for additional axes

- Allows synchronized operation where a robot is installed on an additional axis (linear axis) and its speed relative to the workpiece is specified.
- Supports machining of large workpieces using linear, circular or spline interpolation that exceeds the robot's range of movement.

MELFA Smart Plus

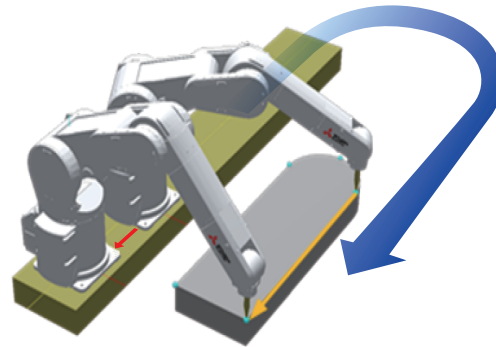

- Allows synchronized operation where tracking of the robot and workpieces on an additional axis (linear axis) is specified.
- Linear or circular interpolation while the workpiece is being transported allows operations such as precision sealing work and surface inspections.

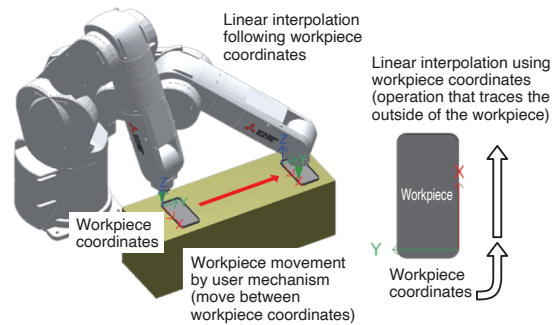

## Robot mechanism temperature compensation function

- Monitors the robot arm temperature and automatically compensates for deviations caused by thermal expansion in the arm.
  - Positional errors due to thermal expansion in the arm when seasonal or time-period-related temperature changes arise are reduced to 1/5th\* of previous levels. (Under Mitsubishi Electric measurement conditions)
- \*It may change depends on models and environment around the robot.

MELFA Smart Plus

### Range error relative to start position

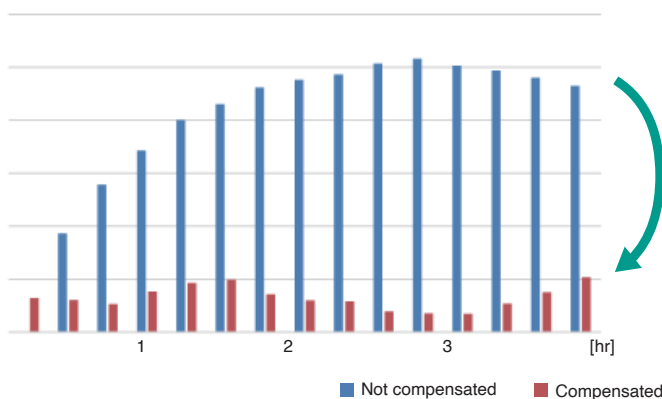

Thermal expansion estimated and corrected

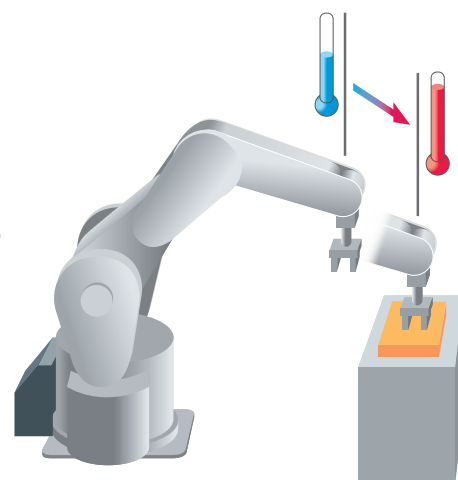







# Enhanced cooperation with FA products

The seamless integration of machines enables flexible manufacturing tailored to the type of production. This improves productivity and maintainability and can reduce the TCO (Total Cost of Ownership).

2

Functions

## iQ Platform

- Collaboration with MELSEC Q series/MELSEC iQ-R series realize more advanced work
- Shorter I/O processing times due to faster communication between CPUs
- PLC management allows large volumes of information to be sent to and from robots in real time
- Allows direct read/write operations to memory shared between robot CPUs

## CC-Link IE Field/SLMP

Allows seamless data communication from production management down to the level of devices

## GOT integration

- Provides easy recipe management through checking of robot operations and information, data collection and setup switching
- Integrates production site operations with the GOT for improved operation and maintainability

## Maintenance

Information before and after errors occur (state changes, I/O, external system variables, etc.) and program run states can be saved as log data, simplifying error identification.

## Easier robot information management

Data specific to robot mechanisms is recorded and saved inside the mechanisms, simplifying maintenance.

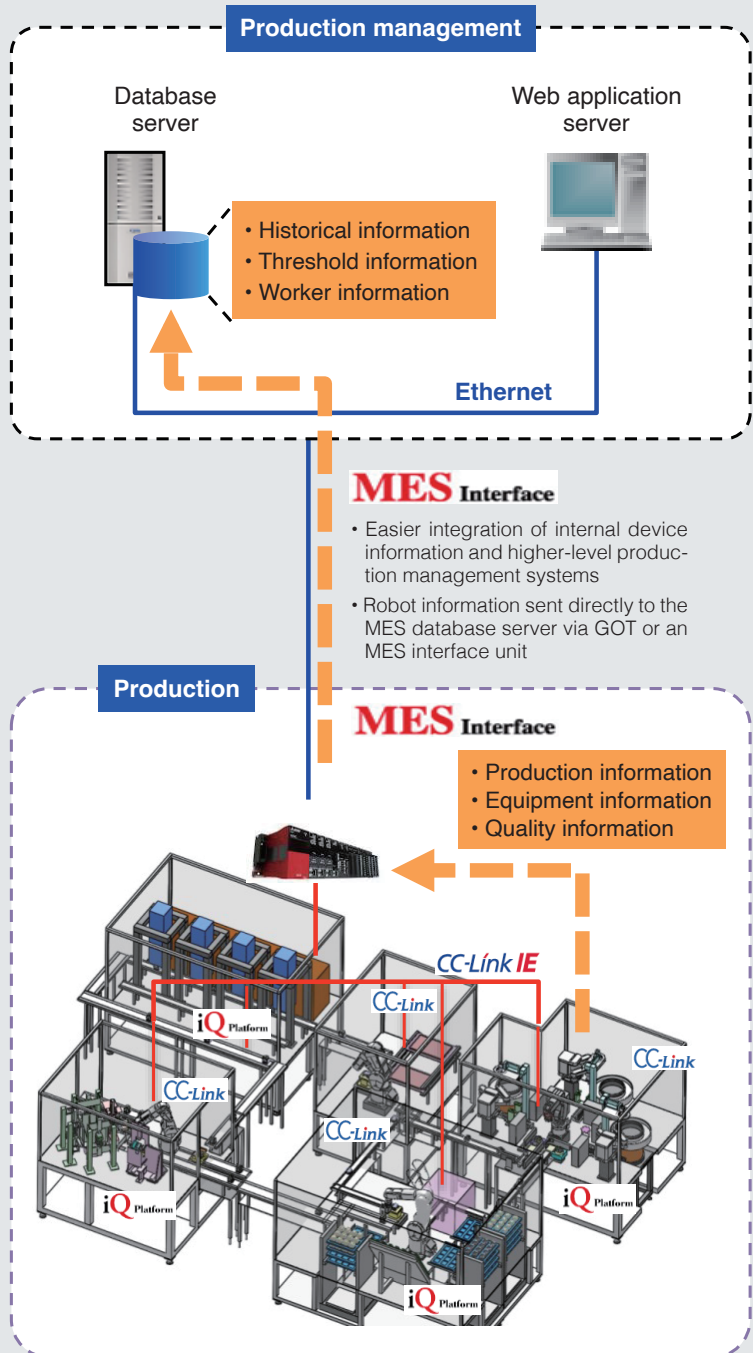

## iQ Platform

Integration with the MELSEC iQ-R series PLCs enables more advanced tasks.

### ■ Better responsiveness due to faster communications

**MELSEC Q Series**



**MELSEC iQ-R Series**



Data exchange cycle among CPUs  
888μs



Data exchange cycle among CPUs  
222μs

Shorter I/O processing times due to faster CPU data communication

### ■ Large volumes of data



• Expanded shared memory area

PLC management allows large volumes of information to be sent to and from robots in real time.

### ■ Direct communication between CPU units



• Improved synchronization  
• Less wasted time

Allows direct read/write operations to memory shared between robot CPUs. Less wasted time because large amounts of data can be shared.

### Batch management of multiple robots

Robots on the PLC network can be accessed from a computer connected to the main CPU. Allows shorter startup times for robots on the production line and improved maintenance.

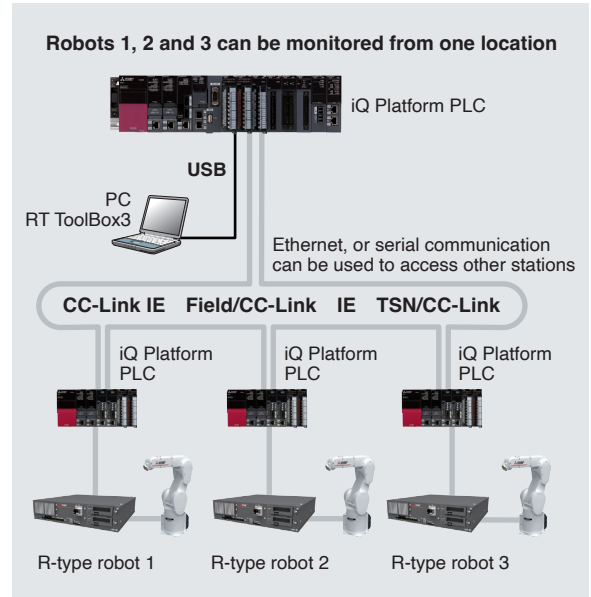

## CC-Link IE Field/SLMP

- Compatible with CC-Link IE Field and SLMP.
- Allows seamless data communication system-wide, from the production management level down to the device level.
- Allows simple connection using just LAN cables.
- Enables general-purpose Ethernet devices compatible with SLMP (vision sensors, etc.) to be used with robot programs.
- Allows robot information (device information) to be collected from higher level devices.

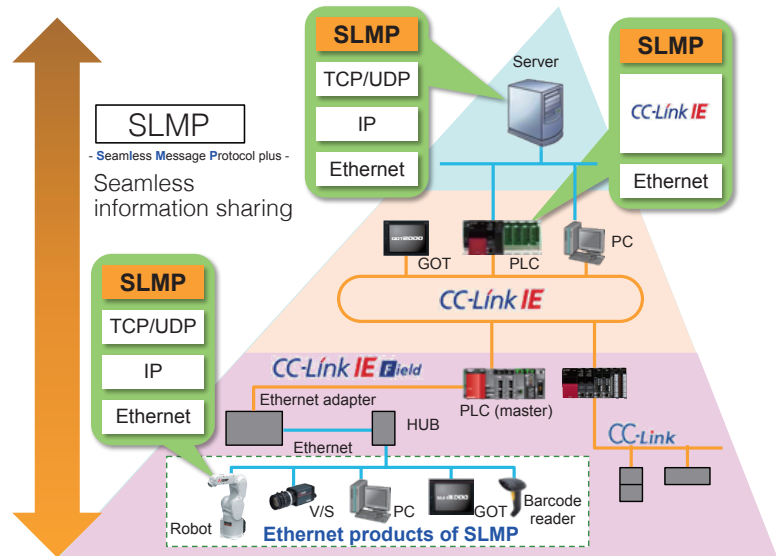

### Various network options

The various network options allow connection to a variety of devices.

**Standard equipment:** Ethernet  
USB  
SSCNET3  
CC-Link IE Field Basic (Ver.A1d or later)

**Option:** CC-Link  
Profibus  
DeviceNet  
Network base card (CC-Link IE Field, EtherNet/IP, PROFINET, EtherCAT)



# Enhanced cooperation with FA products

## GOT integration

The GOT integration function makes it easy to use features such as recipe functions through setup switching, data collection and checking of robot operations and information. Production site HMIs can be integrated with GOT to help improve operation and maintainability.

### GOT backup/restore functions

Data such as robot programs and parameters can be saved (backed up) onto the GOT SD card or USB memory stick using the GOT backup and restore function.

By backing up the GOT beforehand, operation can be restored with the GOT with no need for a personal computer (GT21 and higher). This greatly improves serviceability. The situation is saved even when an unexpected error occurs. This helps prevent data from being lost due to the empty battery or robot malfunction.

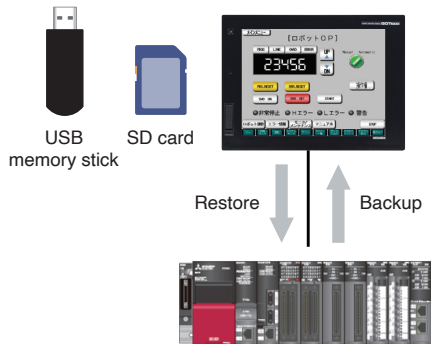

### Device monitoring function

Allows the status of FA equipment such as PLCs, motion controllers, robot controllers and CNCs to be checked without a computer. Useful for tasks such as starting up devices.

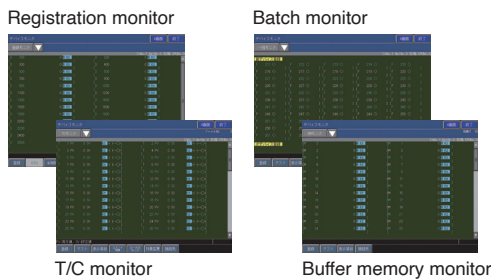

### Logging & graphs list

Uses GOT to collect and display data from equipment such as PLCs and robots. Data can be checked in readily understandable graphs and lists, allowing early identification and analysis of the causes when faults occur.

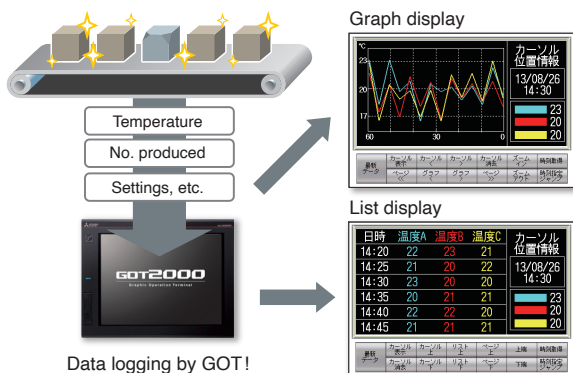

### Shared memory expansion

Enhanced efficiency of monitoring and maintenance operations onsite using a single GOT (display device) as the Human Machine Interface (HMI).

#### Example of GOT display



Enables the robot to be controlled from the GOT even without a teaching box.

Current robot position data, error information, etc. can be displayed easily on the GOT.

#### Internal robot information

- Error, variable, and program information
- Robot status (Current speed, current position, etc.)
- Maintenance information (Remaining battery capacity, grease life, etc.)
- Servo data (Load factor, current values, etc.)

Sample image files can be downloaded from the Mitsubishi Electric FA website.

- Useful sample image files that can immediately be used in actual systems.
- Sample sequence programs (function blocks) are provided for using the sample image files.

Note) The sample image files are for the GT27 (640×480 or better). To use the files, GT Designer3 Version 1.178L or later is required.

### MELFA Smart Plus connection (GOT Drive)

Various GOT connection screens have been prepared to provide full support from robot startup to maintenance. There is also a variety of preventive maintenance and predictive maintenance screens that are compatible with MELFA Smart Plus. These allow you to easily check the condition of overhaul components and confirm maintenance timing.

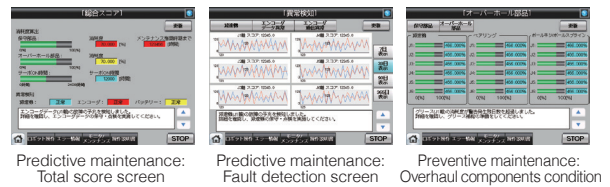

Sample image files can be downloaded from the Mitsubishi Electric FA website.

- FR series GOT2000 sample image files can immediately be used in actual systems.
- Signal control between the GOT and the robot is performed using the GOT scripting language.

Note 1) The sample image files are for the GT27 (640×480 or better). To use the files, GT Designer3 Version 1.178L or later is required.  
 Note 2) If you create a ladder program to control a robot via a programmable controller, neither the GOT nor the ladder program will operate normally.

**Support for the “e-F@ctory” FA integrated solution**

Robot information can be sent to the MES database server using PLCs and MES interface units. The simple system construction allows you to obtain the robot production information (using the device allocation function).

Simple connection and integration of various types of FA devices (PLCs, GOT, servos, etc.). The GOT MES interface function can be used to integrate various types of information from FA devices, including robots, thereby improving productivity and maintainability.

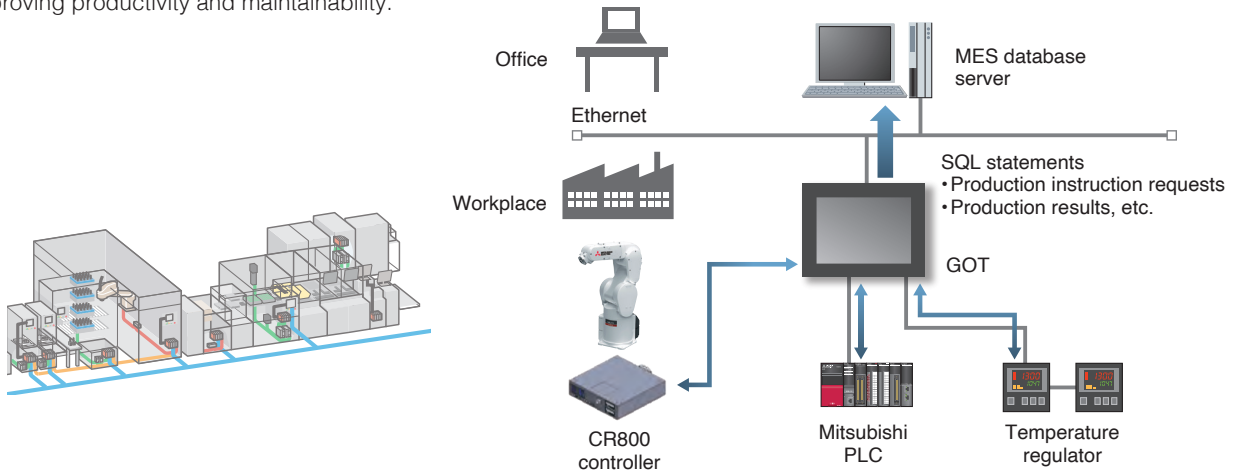

**Recipe function**

Since the data for each product is stored in the GOT with only the necessary data sent to the programmable controller, it is easy to perform setup changes, even with production lines that have a variety of models.

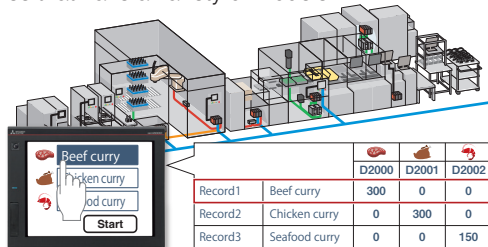

**GOT connection (transparent function)**

The transparent function can be used to edit programs and parameters from the USB interface on the front of the GOT. This makes operation much easier. (For the GT21 model or later)

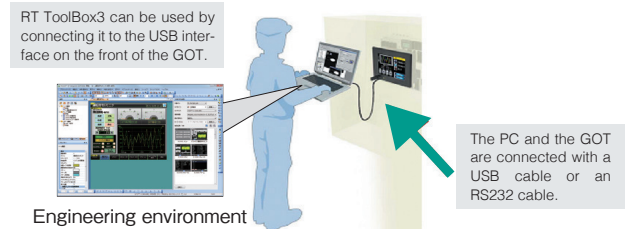

**Maintenance (log function)**

Robot information before and after an error occurs, and the program execution status can be automatically sent to the FTP server or saved on an SD card as log data. The operation log can also be retrieved, so causes of errors can be analyzed efficiently. (RT ToolBox3 is required.)



**Easier robot information management**

Memory is included in the robot body and used to store robot-specific information. This makes it easy to switch robot controllers. Information can also be collected without visiting the workplace, simplifying the formulation of maintenance plans.

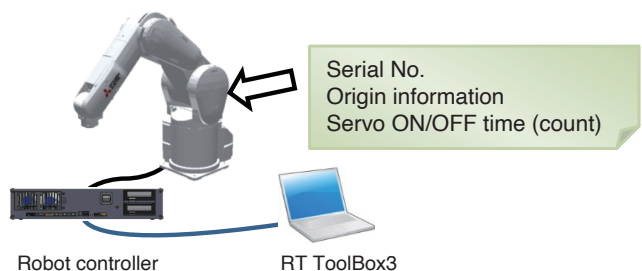



# Improved safety through collaborative work applications

Safety functions ensure that automation is simpler, safer and more user-friendly.

Collaborative human-machine operation support that includes safety options allows working areas to be used jointly by people and robots.

This ensures that factories provide both productivity and flexibility.

\*Customers must conduct risk assessments.

2

Functions

## Safety monitoring function

Safety features are provided that make risk assessment easier.

## Safety I/O

Supports safe system connection through duplicated safe I/O (8 inputs and 4 outputs)

## Safety communication function NEW

CC-Link IE TSN Safety communication function (CR800-R) is supported for a simpler system configuration. It reduces wiring for the safety devices and enables you to directly mount robot CPU modules on the safety CPU module slots.

## Position monitoring function

- Monitors robot positions
- Monitors movement into designated areas (8 locations)

## Speed monitoring function

- Monitors robot speeds
- Also capable of monitoring each of the speed components in the X, Y and Z directions for the monitoring point

## Safety logic editing

Allows the working parameters (logic) of the safety monitoring function to be defined.

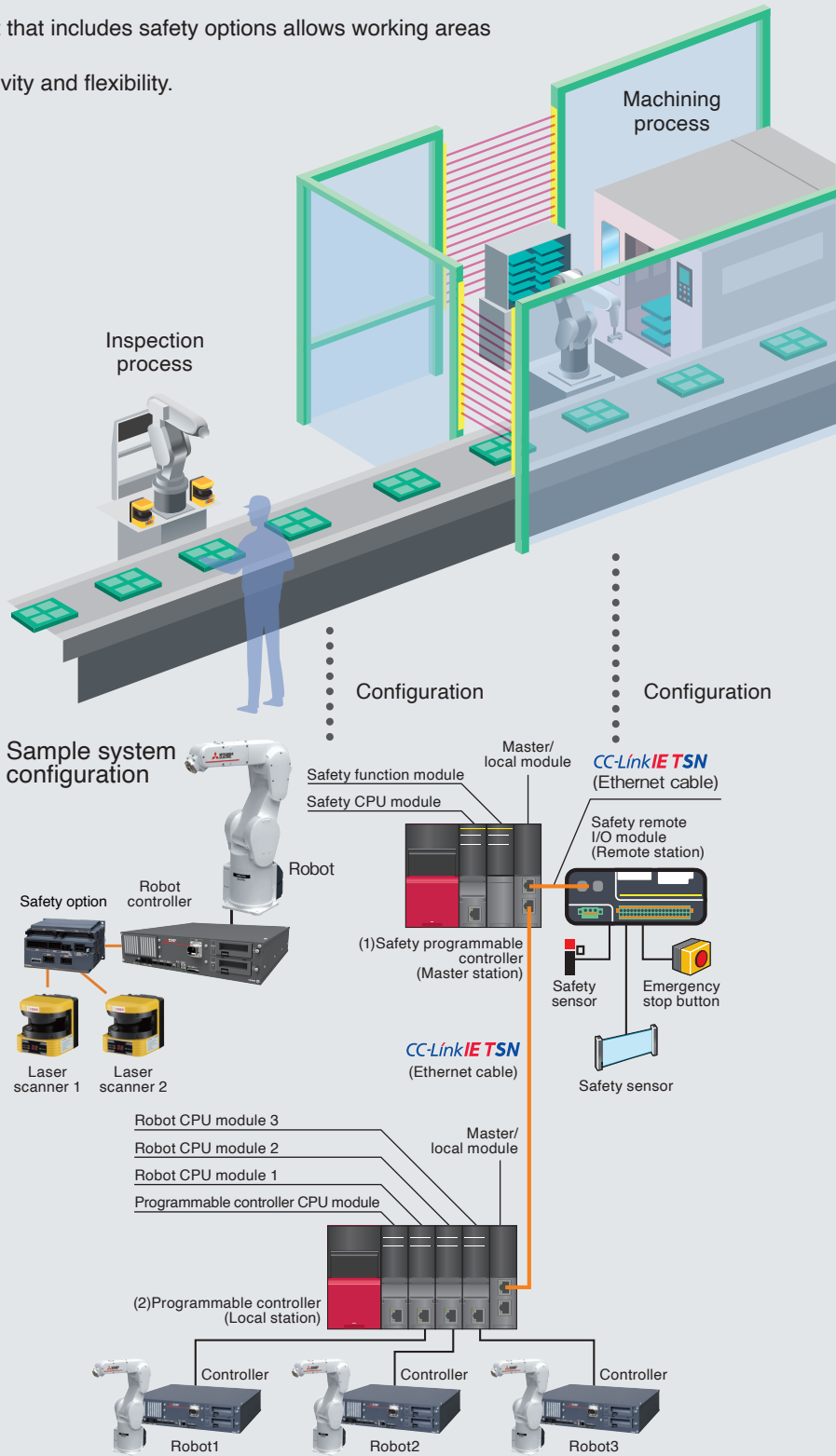

(1) and (2) can also be combined into one configuration. For details, refer to the safety communication function on P. 31.

## Safety option / Features

### Operators can enter an operation area without stopping robots.

- **High safety compliant with international standards**
- **Robot's automatic operation continues even with a safety fence opened.**  
The safety input function enables safety doors to open without causing an emergency stop of the robot.
- **Operators and robots share an operation area. = They can cooperate.**  
While an operator is in a cooperative operation area, a robot does not approach the area. (Operation range limit function)
- **Robots in cooperative operation keeps the safety speed.**  
A robot in cooperative operation continues its operation at the safety speed to secure operator's safety.
- **Robots can automatically shift to single operation from cooperative operation.**  
Closing the safety door switches cooperative operation to single operation, and enables the robot to approach to the shared area.

\*Risk assessment and safety level proof need to be performed for the system. Please contact us if you require any further information.

## Examples of safety options

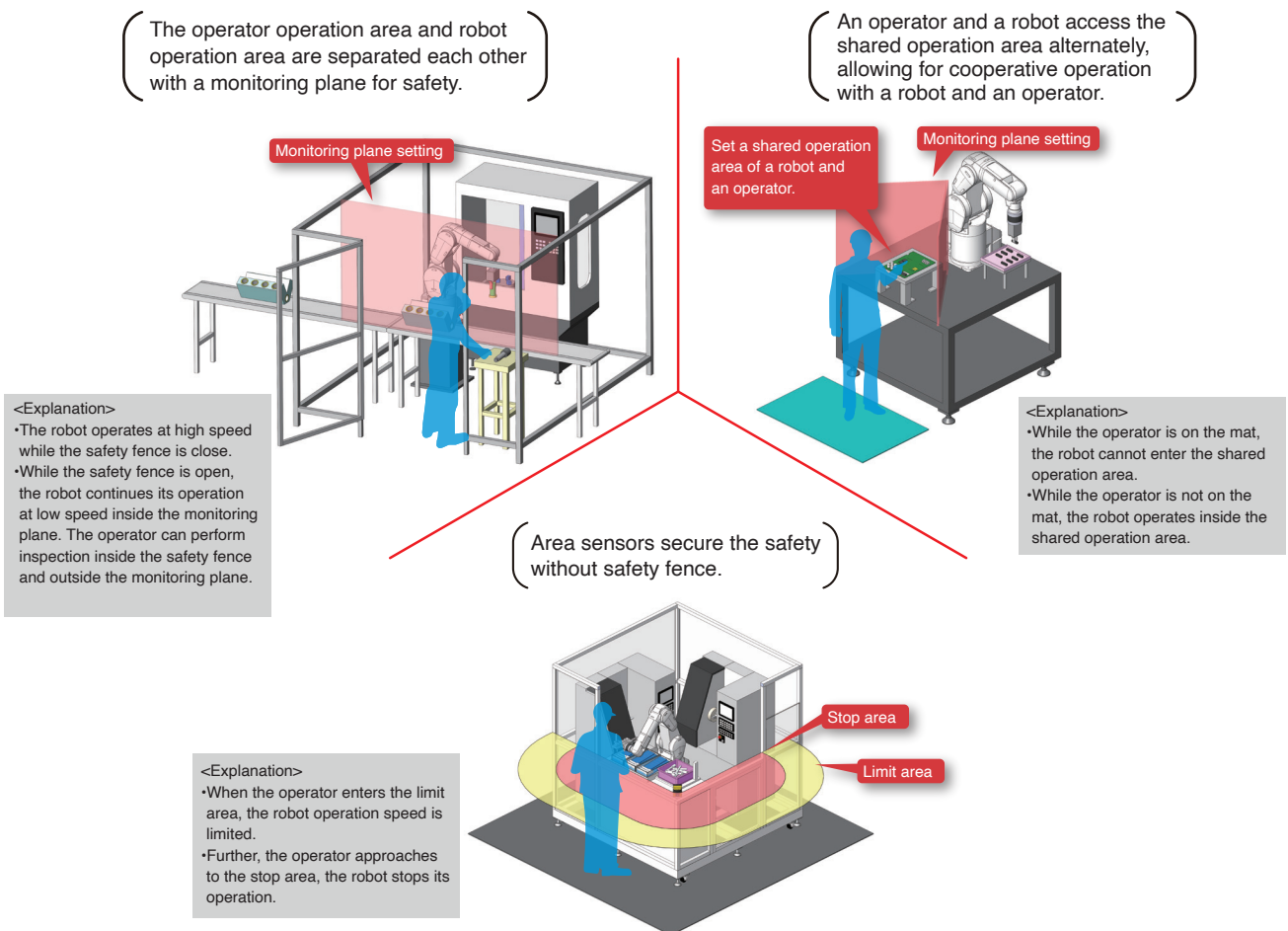



# Improved safety through collaborative work applications

## Safety monitoring function

Safety features that are compliant with the requirements of international standards are provided to make risk assessment easier.

Safety feature <sup>1</sup>	Details	Safety performance <sup>2</sup>	Remarks
STO function	Electrically shuts off driving power to the motors in the robot body.	Category 3, PL d, SIL2 (factory default settings) <sup>3</sup> Category 4, PL e, SIL3 (when parameter settings are changed)	Supported as standard (Safety option not required)
SLS function	Monitors the TCP speed so that it does not exceed the monitoring speed.		
SLP function	Monitors a specified monitoring position so that it does not go beyond the position monitoring surface.		
SOS function	Monitors the robot to ensure that it does not move from its stop position.		
SS1 function	Function stopped by STO.		
SS2 function	Function stopped by SOS.		

<sup>1</sup> Safety features are based on EN 61800-5-2. <sup>2</sup> Safety performance is based on IEC/EN 61508 and EN ISO 13849-1.

<sup>3</sup> The STO function meets the requirements of SIL2, Category 3, and PL d when activated by the robot controller's external emergency stop input (when input diagnosis by test pulse is not set) and the safety extension unit input signal of the safety option. The STO function meets the requirements of SIL2, Category 4, and PL e when activated by the robot controller's external emergency stop input (when input diagnosis by test pulse is set) and CC-Link IE TSN safety communication function.

## Safety I/O

Expands duplicated safe I/O to 8 inputs and 4 outputs. Allows the construction of various different safety systems.

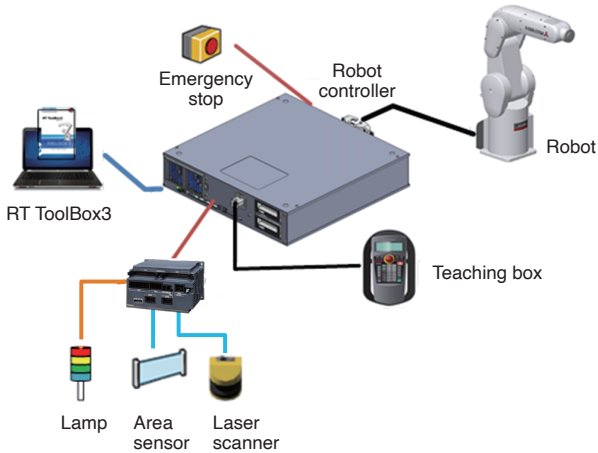

## Safety communication function NEW

CC-Link IE TSN Safety communication function (CR800-R) is supported for a simpler system configuration. It reduces wiring for the safety devices and enables you to directly mount robot CPU modules on the safety CPU module slots.

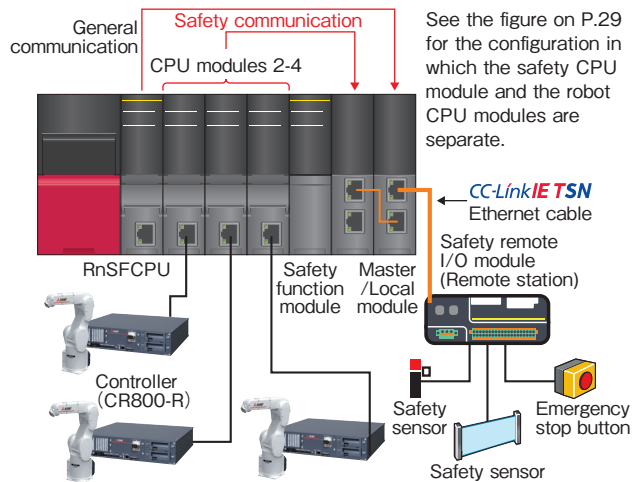

See the figure on P.29 for the configuration in which the safety CPU module and the robot CPU modules are separate.

## Speed monitoring function

- Monitors robot speeds
- Monitors designated monitoring points on the the robot arm and gripper to ensure that they do not exceed the monitoring speed.

- Also allows monitoring of each of the X-, Y- and Z-direction components for each monitoring point. By setting a low monitoring speed in the system for directions in which the robot does not move, safe distances can be made smaller to create compact cells safely.

Monitoring points: 4 locations on the robot arm

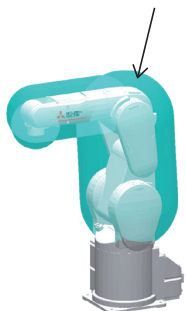

Monitoring points: 4 locations on the gripper

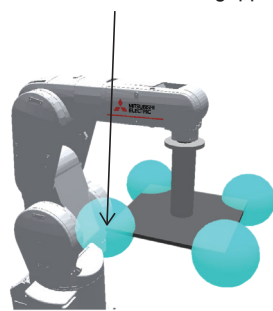

Without speed monitoring

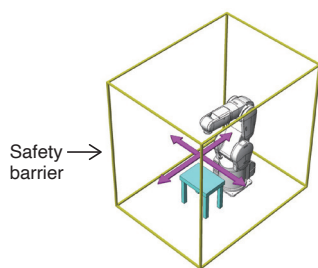

Robot movement direction/speed

With speed monitoring

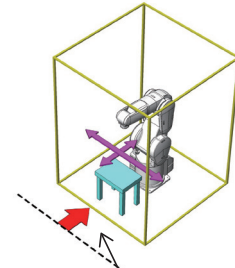

Low monitoring speed set for forward-backward robot movement → Small safe distance (more compact)



### Stoppage monitoring function

- This function monitors the robot for any stoppages without interrupting the power supply to the motors.

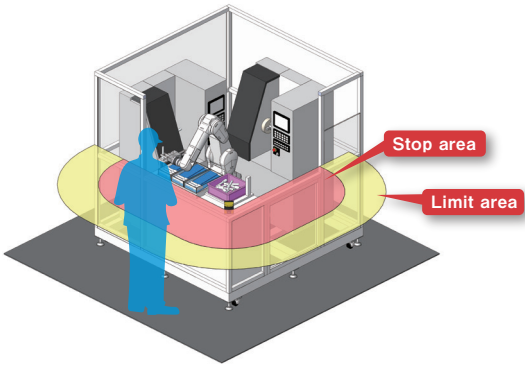

### Position monitoring function

- Monitors robot positions.
- Monitors movement into designated areas in up to 8 locations.

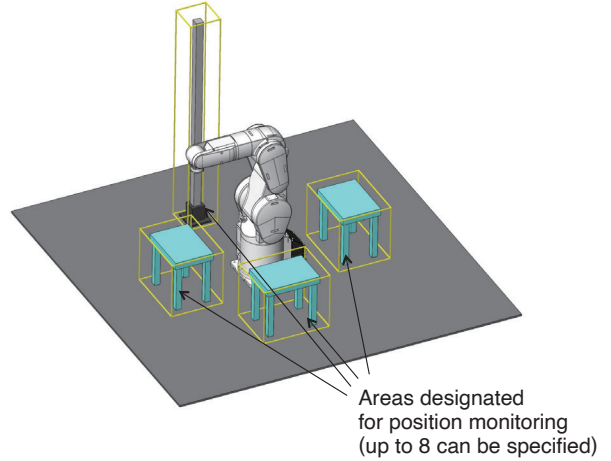

### Safety logic editing

The safety logic editing function makes it easy to construct and operate safety systems. Because it allows you to freely define the operating parameters (logic) for the safety monitoring functions in the robot controller, you can configure the safety monitoring conditions without having to use a safety CPU.

By configuring the parameters in the editing screen, you can utilize interlock monitoring that combines safety I/O and position monitoring.

Position monitoring: Activates the specified function according to the position of the robot.

Interlock monitoring: Activates the specified safety function according to the position of another robot.

#### Usage scenarios

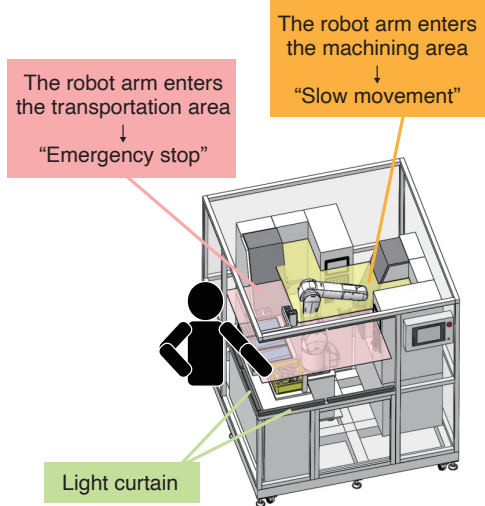

On/Off setting for each safety function

Safe I/O    Position monitoring    Logic expression for safe I/O and position monitoring

	SS1	SS2	SLS1	SLS2	SLS3	SLSM	SLP1	SLP2	SLP3	SLP4
DSI1	<input type="checkbox"/>	<input type="checkbox"/>	<input type="checkbox"/>	<input type="checkbox"/>	<input type="checkbox"/>	<input type="checkbox"/>	<input type="checkbox"/>	<input type="checkbox"/>	<input type="checkbox"/>	<input type="checkbox"/>
DSI2	<input type="checkbox"/>	<input type="checkbox"/>	<input checked="" type="checkbox"/>	<input type="checkbox"/>	<input type="checkbox"/>	<input type="checkbox"/>	<input type="checkbox"/>	<input type="checkbox"/>	<input type="checkbox"/>	<input type="checkbox"/>
DSI3	<input type="checkbox"/>	<input type="checkbox"/>	<input type="checkbox"/>	<input type="checkbox"/>	<input type="checkbox"/>	<input type="checkbox"/>	<input type="checkbox"/>	<input type="checkbox"/>	<input type="checkbox"/>	<input type="checkbox"/>
DSI4	<input type="checkbox"/>	<input type="checkbox"/>	<input type="checkbox"/>	<input type="checkbox"/>	<input type="checkbox"/>	<input type="checkbox"/>	<input type="checkbox"/>	<input type="checkbox"/>	<input type="checkbox"/>	<input type="checkbox"/>
DSI5	<input type="checkbox"/>	<input type="checkbox"/>	<input type="checkbox"/>	<input type="checkbox"/>	<input type="checkbox"/>	<input type="checkbox"/>	<input type="checkbox"/>	<input type="checkbox"/>	<input type="checkbox"/>	<input type="checkbox"/>
DSI6	<input type="checkbox"/>	<input type="checkbox"/>	<input type="checkbox"/>	<input type="checkbox"/>	<input type="checkbox"/>	<input type="checkbox"/>	<input type="checkbox"/>	<input type="checkbox"/>	<input type="checkbox"/>	<input type="checkbox"/>
DSI7	<input type="checkbox"/>	<input type="checkbox"/>	<input type="checkbox"/>	<input type="checkbox"/>	<input type="checkbox"/>	<input type="checkbox"/>	<input type="checkbox"/>	<input type="checkbox"/>	<input type="checkbox"/>	<input type="checkbox"/>
DSI8	<input type="checkbox"/>	<input type="checkbox"/>	<input type="checkbox"/>	<input type="checkbox"/>	<input type="checkbox"/>	<input type="checkbox"/>	<input type="checkbox"/>	<input type="checkbox"/>	<input type="checkbox"/>	<input type="checkbox"/>
AREA1	<input type="checkbox"/>	<input type="checkbox"/>	<input type="checkbox"/>	<input type="checkbox"/>	<input type="checkbox"/>	<input type="checkbox"/>	<input type="checkbox"/>	<input type="checkbox"/>	<input type="checkbox"/>	<input type="checkbox"/>
AREA2	<input type="checkbox"/>	<input type="checkbox"/>	<input type="checkbox"/>	<input type="checkbox"/>	<input type="checkbox"/>	<input type="checkbox"/>	<input type="checkbox"/>	<input type="checkbox"/>	<input type="checkbox"/>	<input type="checkbox"/>
AREA3	<input type="checkbox"/>	<input type="checkbox"/>	<input type="checkbox"/>	<input type="checkbox"/>	<input type="checkbox"/>	<input type="checkbox"/>	<input type="checkbox"/>	<input type="checkbox"/>	<input type="checkbox"/>	<input type="checkbox"/>
LOGIC	<input type="checkbox"/>	<input type="checkbox"/>	<input type="checkbox"/>	<input type="checkbox"/>	<input type="checkbox"/>	<input type="checkbox"/>	<input type="checkbox"/>	<input type="checkbox"/>	<input type="checkbox"/>	<input type="checkbox"/>
MODE	<input type="checkbox"/>	<input type="checkbox"/>	<input type="checkbox"/>	<input type="checkbox"/>	<input type="checkbox"/>	<input type="checkbox"/>	<input type="checkbox"/>	<input type="checkbox"/>	<input type="checkbox"/>	<input type="checkbox"/>
	<input type="checkbox"/>	<input type="checkbox"/>	<input type="checkbox"/>	<input type="checkbox"/>	<input type="checkbox"/>	<input type="checkbox"/>	<input type="checkbox"/>	<input type="checkbox"/>	<input type="checkbox"/>	<input checked="" type="checkbox"/>

DSI Filter Time: 10 [ms]

Write

Safety logic editing screen

# Program Creation and Total Engineering Support Software

## RT ToolBox3

This is computer software to assist with a range of tasks from system startup through to debugging and operation. This includes creating and editing programs, checking the operating environment prior to robot installation, estimating cycle times, debugging when robots are started up, monitoring robots states once they are running and monitoring faults. Its features include a ribbon bar, output window and docking pane, making information easier to see and the software easier to use. Operations in the 3D monitor screen have also been updated to make using the screen more intuitive.

RT ToolBox3 mini	Simplified version. Offers programming, debugging, and monitoring functions.
RT ToolBox3	Includes simulation functions. May also be used for preliminary examinations.
RT ToolBox3 PRO	Runs on 3DCAD (SolidWorks). Allows even more realistic examinations. CAD data can also be used for path generation and operation programs.

2

Functions

### Program editing and debugging

Auto-complete and fold functions make programming easier to use.

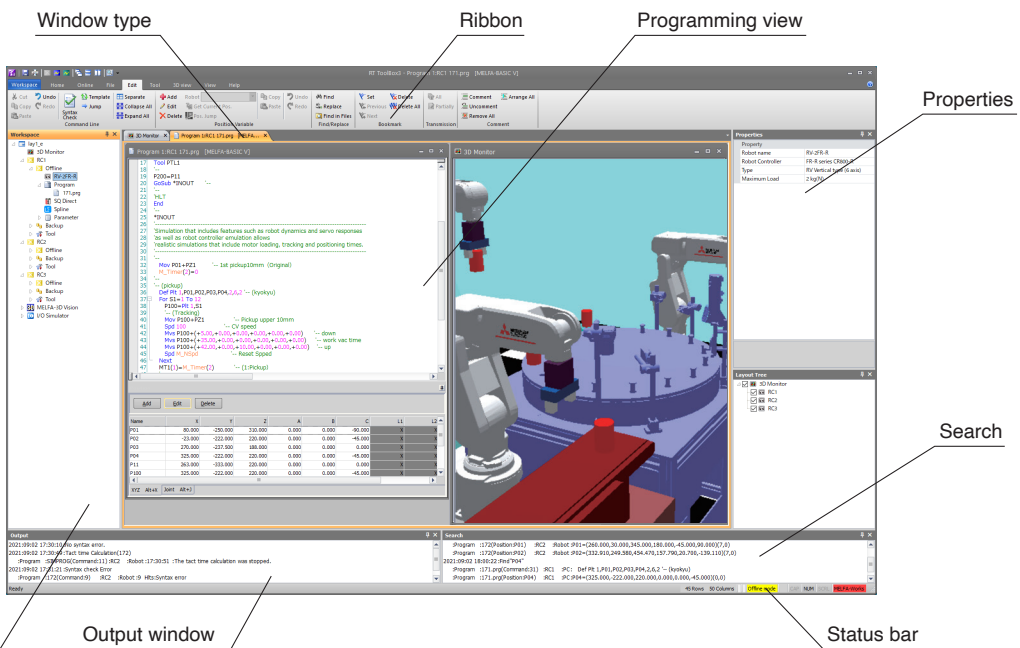

### Simulation function

Simulation that includes features such as robot dynamics and servo responses as well as robot controller emulation allows realistic simulations that include motor loading, tracking and positioning times.

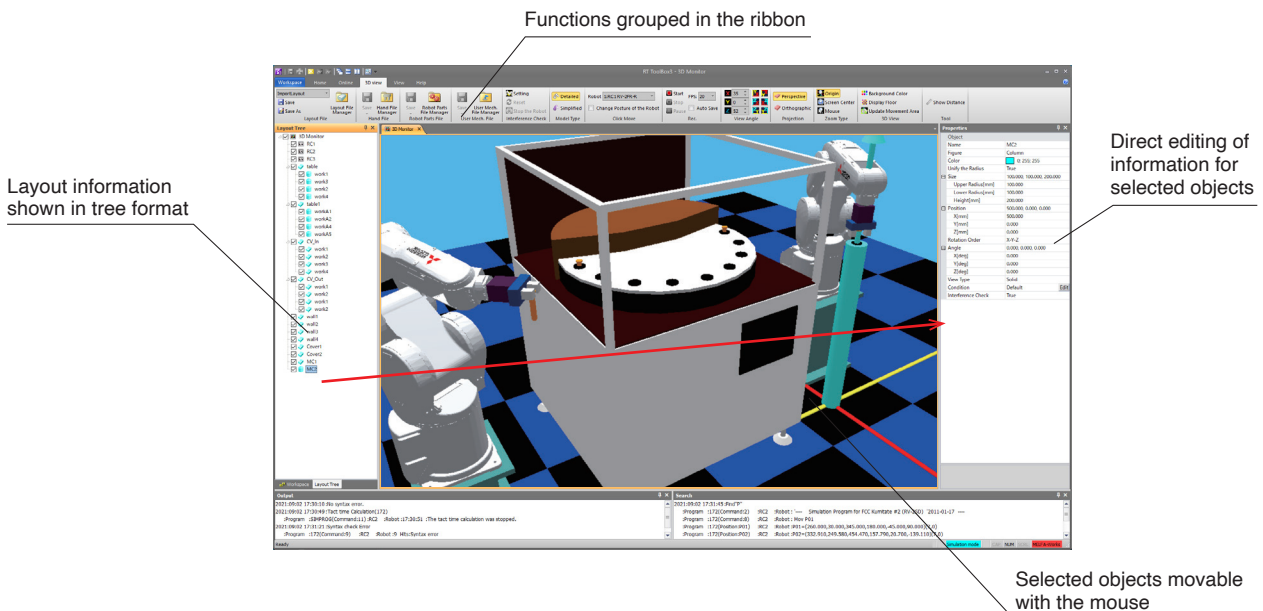

### 3D viewer

The 3D viewer can be used to check the robot attitude and operation and to visually check information such as limit values for user-defined areas, etc.

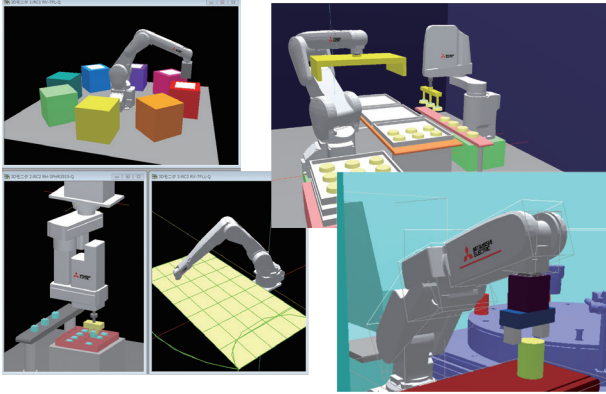

### Real time external control

Robot movement can be controlled from the computer using synchronous units.

### Melfa RXM.ocx communications middleware

Allows RT ToolBox functions to be run from computer applications.

### Monitoring functions

As well as monitoring program run states, variables, input/output signals and other events, these functions can show graphs of robot operation waveforms (speeds and current values) and I/O states in real time. This makes it easy to see the correlation between program execution steps and waveform data, making debugging markedly more efficient.



Monitoring screens

## MELFA BASIC VI

As well as providing a more complete set of commands, this uses structured programming to give high levels of reusability and readability.

### Structured programming

Allows structured programs, enabling programming with high levels of reusability and readability. (Also supports existing programming methods.)

```

1 Function Main 'Entry point
2 MResult = FnMMove(P1, P2)
3 MResult = FnMMove(P3, P4)
4 FEnd
5
6 Function FnMMove(P1, P2) 'User function
7 Mov P1
8 Mov P2
9 Return 1
10 FEnd
    
```

### Library function

Keeping a library of program processing allows knowledge to be accumulated and provides improved reusability. The libraries can also be hidden to prevent knowledge from being disclosed.

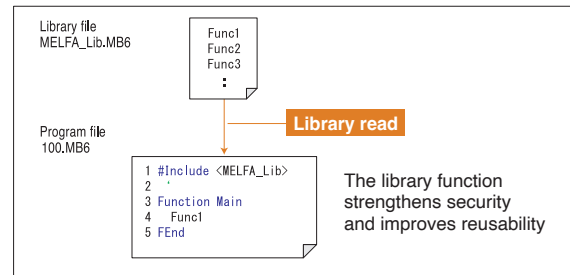

## Visual programming

RT ToolBox3 includes the visual programming function of RT VisualBox.

Visual programming enables intuitive operation. It is easy to start up robots even without knowledge of robotics.

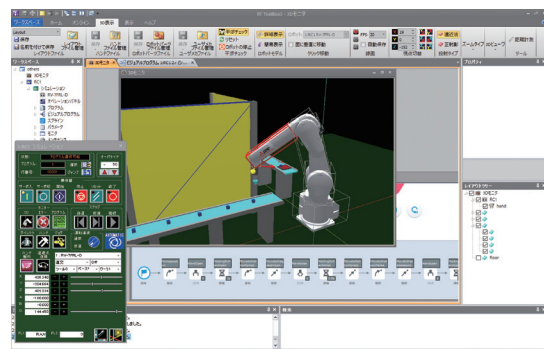
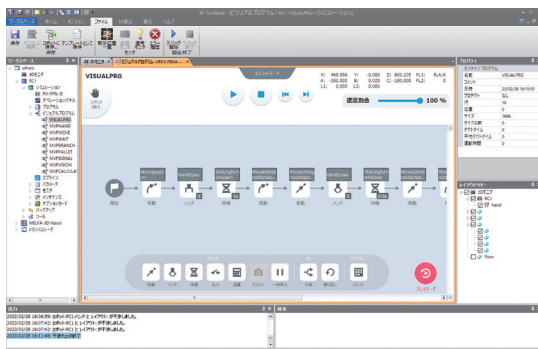

# MELFA RV-2FR RV-2FRL

## Vertical 2kg type

### RV-2FR RV-2FRL

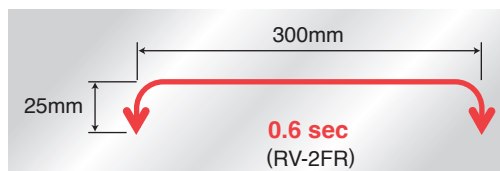
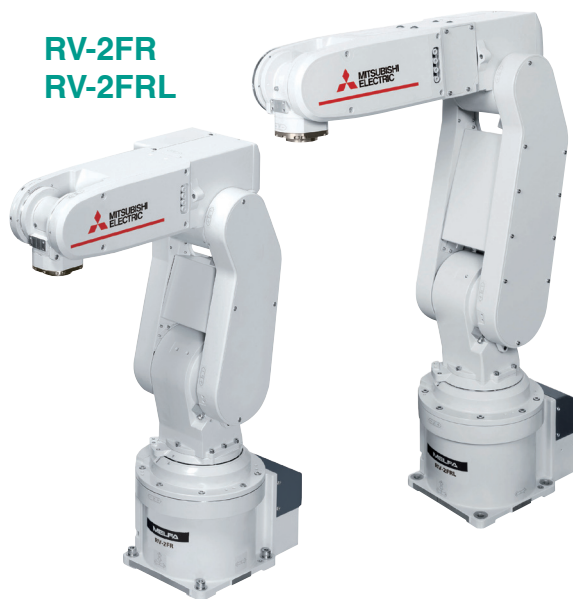

Compact body and slender arms cover large work areas. An ideal robot for compact cell construction. Perfect for transporting, assembling and inspecting small components.

- Among the fastest moving robots in its class  
[Max. composite speed: 5.0 m/s] (RV-2FR)
- Standard cycle time  
[0.6 second range] (RV-2FR)
- Pivotal operating range:  $\pm 240^\circ$
- Environmental specifications [standard: IP30]
- Standards compliance  
Compliant with European Machinery Directives (CE) as standard. Compliance with other standards is available in specialized machines. Contact Mitsubishi Electric for details.

### ► Specifications

Item	Unit	RV-2FR (B)	RV-2FRL (B)
Environmental specifications		Standard	
Protection degree		IP30	
Installation		Floor type, ceiling type, (wall-mounted type *2)	
Structure		Vertical multiple-joint type	
Degrees of freedom		6	
Drive system *1		AC servo motor (J2, J3 and J5: with brake)	
Position detection method		Absolute encoder	
Maximum load capacity	kg	Maximum 3 (Rated 2) *5	
Arm length	mm	230+270	310+335
Maximum reach radius	mm	504	649
Operating range	J1	480 ( $\pm 240$ )	
	J2	240 ( $\pm 120$ )	237 (-117 to +120)
	J3	160 (-0 to +160)	
	J4	400 ( $\pm 200$ )	
	J5	240 ( $\pm 120$ )	
	J6	720 ( $\pm 360$ )	
Maximum speed	J1	300	225
	J2	150	105
	J3	300	165
	J4	450	412
	J5	450	
	J6	720	
Maximum composite speed *3	mm/sec	4955	4200
Cycle time *4	sec	0.6	0.7
Position repeatability	mm	$\pm 0.02$	
Ambient temperature	$^\circ\text{C}$	0 to 40	
Mass	kg	19	21
Tolerable moment	J4	4.17	
	J5	4.17	
	J6	2.45	
Tolerable amount of inertia	J4	0.18	
	J5	0.18	
	J6	0.04	
Tool wiring		Gripper: 4 input points/4 output points Signal cable for the multi-function gripper	
Tool pneumatic pipes		$\Phi 4 \times 4$	
Machine cable		5m (connector on both ends)	
Connected controller *6		CR800-D, CR800-R, CR800-Q	

► External Dimensions/Operating Range Diagram

**RV-2FR**

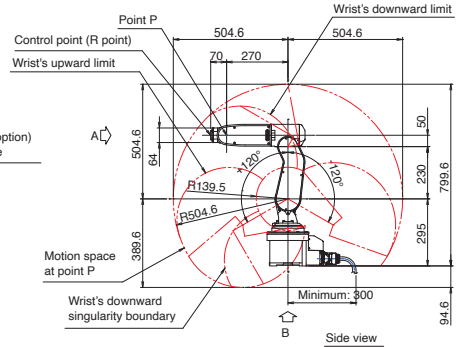
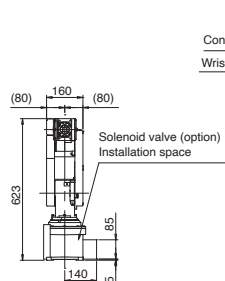
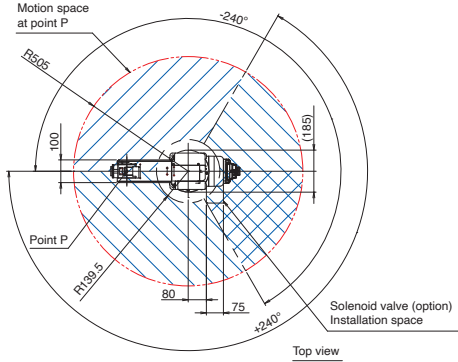

Operating range for each axis:  
J1: ±240°  
J2: ±120°  
J3: 0° to 160°  
J4: ±200°  
J5: ±120°  
J6: ±360°

**RV-2FRL**

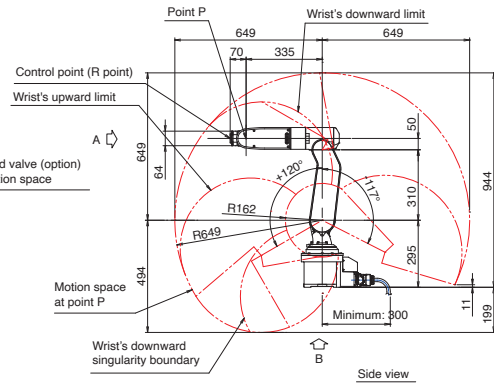
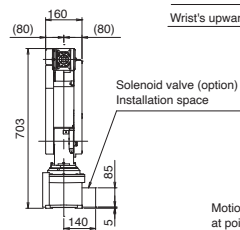
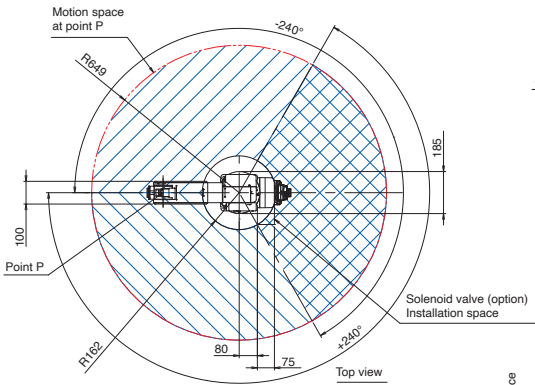

Operating range for each axis:  
J1: ±240°  
J2: +120° to -117°  
J3: 0° to 160°  
J4: ±200°  
J5: ±120°  
J6: ±360°

**Shared parts**

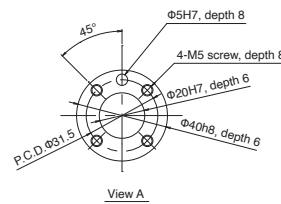
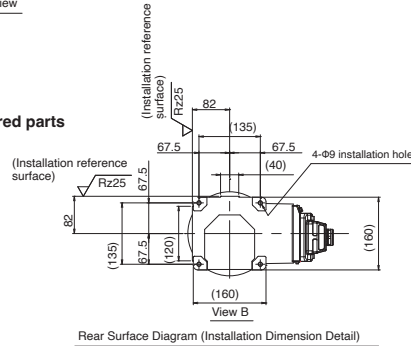

\*Operating range limit  
When the J1-axis angle is inside the range of -75° < J1 < 70° and the J2-axis angle is J2 < -110°, operating range of the J3-axis is limited to 80° ≤ J3.

**RV-2FR**

**RV-2FR-D**

**Robot structure**

RV: Vertical, multiple-joint type

**Maximum load capacity**

2: 2kg

**Series**

FR: FR series

**Controller type**

D: CR800-D

R: CR800-R

Q: CR800-Q

**Brake specification**

Blank: No brake for J1, J4 and J6 axis

B: All axis with brake

**RV-2FRL**

**RV-2FRL-D**

**Robot structure**

RV: Vertical, multiple-joint type

**Maximum load capacity**

2: 2kg

**Series**

FR: FR series

**Controller type**

D: CR800-D

R: CR800-R

Q: CR800-Q

**Brake specification**

Blank: No brake for J1, J4 and J6 axis

B: All axis with brake

**Arm length**

Blank: Standard arm

L: Long arm

\*1: The standard model does not have a brake on the J1, J4, or J6 axis. There are models available with brakes included for all axes.

\*2: The wall-mounted specification is a custom specification where the operating range of the J1-axis is limited.

\*3: This is the value at the surface of the mechanical interface when all axes are composited.

\*4: The cycle time is based on back-and-forth movement over a vertical distance of 25 mm and horizontal distance of 300 mm when the load is 1 kg.

\*5: The maximum load capacity indicates the maximum payload when the mechanical interface is facing downward (±10° to the perpendicular).

\*6: Select a controller according to the application. CR800-D: Standalone type, CR800-R: MELSEC iQ-R compatible type, CR800-Q: MELSEC Q compatible type.

# MELFA RV-4FR RV-4FRL

## Vertical 4kg type

### RV-4FR RV-4FRL

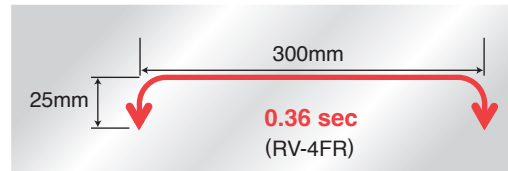

Cutting-edge servo control and optimized arm construction provide extremely fast and precise heavy-duty operation. Flap-style arms provide a range of movement ideally suited to compact areas. The use of space is highly efficient. Perfect for transporting, assembling and inspecting small components.

- Among the fastest moving robots in its class  
[Max. composite speed: 9.0 m/s]
- Standard cycle time  
[0.36 s]
- Pivotal operating range:  $\pm 240^\circ$
- Environmental specifications  
[standard: IP40; oil mist: IP67; cleanroom: ISO class 3]
- Standards compliance  
Compliant with European Machinery Directives (CE) as standard.  
Compliance with other standards is available in specialized machines.  
Contact Mitsubishi Electric for details.

### Specifications

Item	Unit	RV-4FR (M) (C)	RV-4FRL (M) (C)
Environmental specifications		Standard/ Oil mist/ Cleanroom	
Protection degree		IP40 (standard)/ IP67 (oil mist) *1/ ISO class3 *7	
Installation		Floor type, ceiling type, (wall-mounted type *2)	
Structure		Vertical multiple-joint type	
Degrees of freedom		6	
Drive system		AC servo motor	
Position detection method		Absolute encoder	
Maximum load capacity	kg	Maximum 4 (Rated 4) *8	
Arm length	mm	235+275	310+335
Maximum reach radius	mm	515	649
Operating range	J1	480 ( $\pm 240$ )	
	J2	240 ( $\pm 120$ )	
	J3	161 (-0 to +161)	164 (-0 to +164)
	J4	400 ( $\pm 200$ )	
	J5	240 ( $\pm 120$ )	
	J6	720 ( $\pm 360$ )	
Maximum speed	J1	450	420
	J2	450	336
	J3	300	250
	J4	540	540
	J5	623	623
	J6	720	720
Maximum composite speed *3	mm/sec	9027	9048
Cycle time *4	sec	0.36	0.36
Position repeatability	mm	$\pm 0.02$	
Ambient temperature	$^\circ\text{C}$	0 to 40	
Mass	kg	39	41
Tolerable moment	J4	6.66	
	J5	6.66	
	J6	3.96	
Tolerable amount of inertia	J4	0.2	
	J5	0.2	
	J6	0.1	
Tool wiring		Gripper: 8 input points/8 output points Signal cable for the multi-function gripper and sensors LAN x 1 <100 BASE-TX> *5	
Tool pneumatic pipes		Primary: $\Phi 6 \times 2$ Secondary: $\Phi 4 \times 8, \Phi 4 \times 4$ (from base portion to forearm)	
Machine cable		5m (connector on both ends)	
Connected controller *6		CR800-D, CR800-R, CR800-Q	

**External Dimensions/Operating Range Diagram**

**RV-4FR**

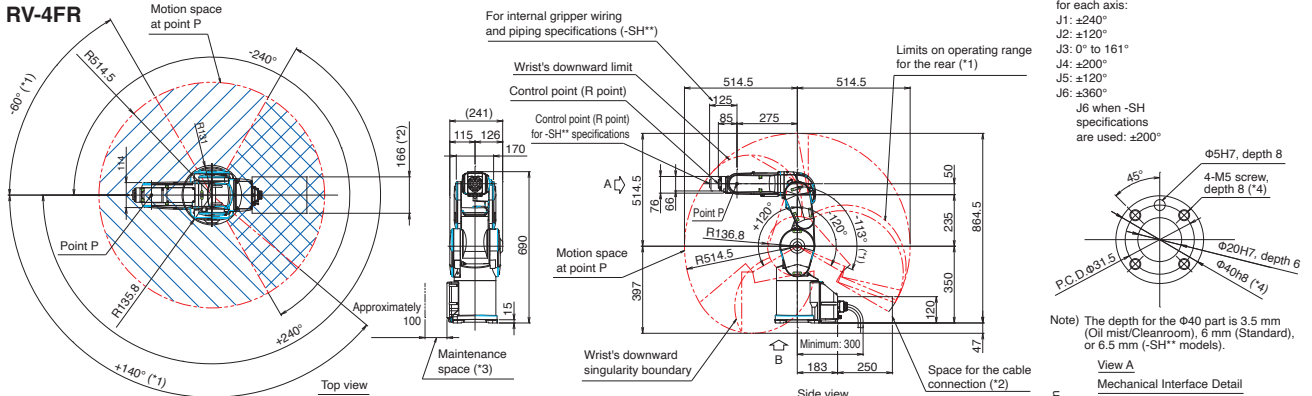

- Notes  
 \*1: Limits on the operating range for the back and side parts: When the J1-axis angle is inside the range of  $-60^\circ \leq J1 \leq 140^\circ$ , the operating range of the J2-axis is limited to  $-113^\circ \leq J2 \leq 120^\circ$ .  
 \*2: Make sure to leave enough space open for cable connections between devices.  
 \*3: Make sure to leave enough space open for removing and attaching covers during maintenance work.  
 \*4: Specify a thread engagement length of 7.5 to 8 mm.

**RV-4FRL**

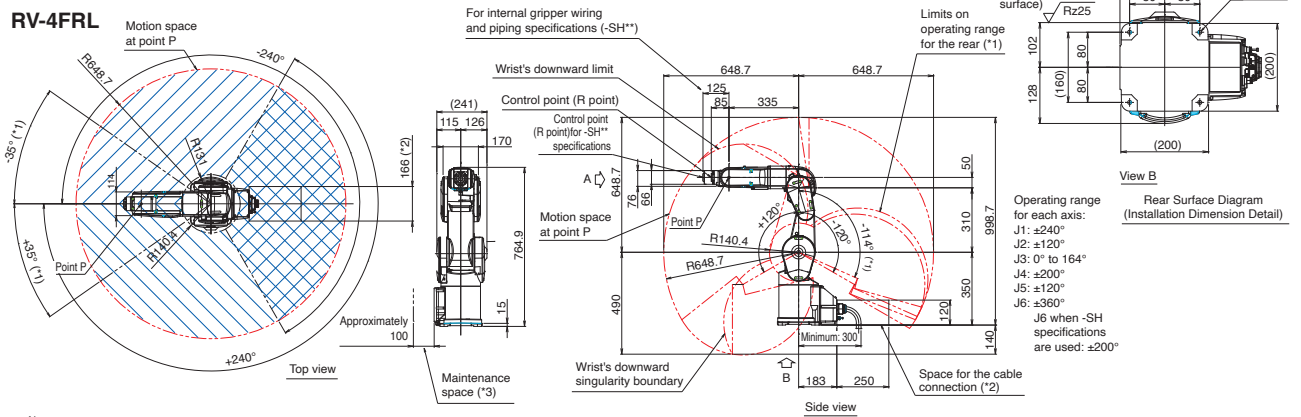

- Notes  
 \*1: Limits on the operating range for the back and side parts: When the J1-axis angle is inside the range of  $-35^\circ \leq J1 \leq 35^\circ$ , the operating range of the J2-axis is limited to  $-114^\circ \leq J2 \leq 120^\circ$ .  
 \*2: Make sure to leave enough space open for cable connections between devices.  
 \*3: Make sure to leave enough space open for removing and attaching covers during maintenance work.  
 \*4: Specify a thread engagement length of 7.5 to 8 mm.

**Mounting cable specifications (\*1)**

Devices that can be mounted	Model (machine no.)				
	-SH01	-SH02	-SH03	-SH04	-SH05
Air $\Phi 4$	<input type="radio"/> (x4)	-	-	<input type="radio"/> (x2)	<input type="radio"/> (x2)
Gripper input 8 points	<input type="radio"/>	<input type="radio"/>	<input type="radio"/>	<input type="radio"/>	<input type="radio"/>
Vision sensor	-	<input type="radio"/>	<input type="radio"/>	-	<input type="radio"/>
Force sensor	-	<input type="radio"/>	<input type="radio"/>	-	-
Electric gripper	-	<input type="radio"/>	<input type="radio"/>	-	-

(may be used for either device)

\*1) The J6 axis range of motion is  $\pm 200$ deg. Protection level is IP40.

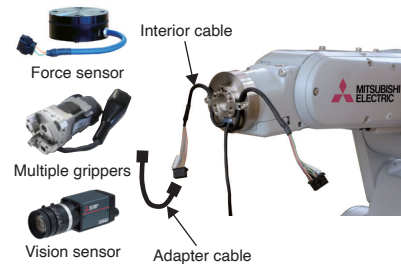

**RV-4FRL - D -**

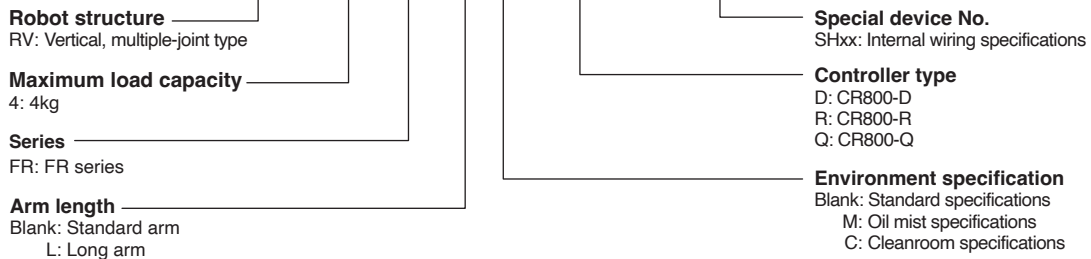

- \*1: Please contact Mitsubishi Electric dealer since the environmental resistance may not be secured depending on the characteristics of oil you use. Air will need to be purged from the lines. For details, refer to the specifications sheet.  
 \*2: The wall-mounted specification is a custom specification where the operating range of the J1-axis is limited.  
 \*3: This is the value at the surface of the mechanical interface when all axes are composited.  
 \*4: Value for a 25mm up/down and 300mm horizontal reciprocal movement with 1kg load. The cycle time is the value for RV-4FR-R and RV-4FRL-R.  
 \*5: This can also be used as a spare wire (0.13sq 4-pair wire.) The wire is prepared up to inside the forearm.  
 \*6: Select one of the following controllers according to the application. CR800-D: Standalone type, CR800-R: MELSEC iQ-R compatible type, CR800-Q: MELSEC Q Series compatible type.  
 \*7: Preservation of cleanliness levels depends on conditions of a downstream flow of 0.3 m/s in the cleanroom and internal robot suctioning. A  $\Phi 8$ -mm coupler for suctioning is provided at the back of the base.  
 \*8: The maximum load capacity indicates the maximum payload when the mechanical interface is facing downward ( $\pm 10^\circ$  to the perpendicular).

# MELFA RV-7FR RV-7FRL RV-7FRL

## Vertical 7kg type

### RV-7FR RV-7FRL RV-7FRL



Cutting-edge servo control and optimized arm construction provide extremely fast and precise heavy-duty operation. Increased range of movement along each axis and slender arms to cover large work areas. An ideal robot for compact cell construction. The product line includes a model with a maximum reach radius of 1503 mm for a larger operating range.

- Among the fastest moving robots in its class  
[Max. composite speed: 11.0 m/s (RV-7FR)]
- Standard cycle time [0.32 s (RV-7FR)]
- Pivotal operating range:  $\pm 240^\circ$  (RV-7FR/7FRL)
- Environmental specifications  
[standard: IP40; oil mist: IP67; cleanroom: ISO class 3]
- Standards compliance  
Compliant with European Machinery Directives (CE) as standard.  
Compliance with other standards is available in specialized machines.  
Contact Mitsubishi Electric for details.

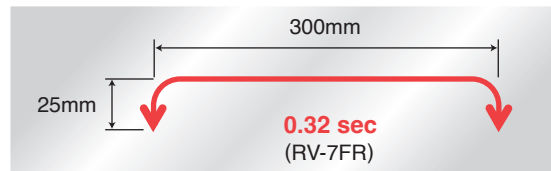

### Specifications

Item	Unit	RV-7FR (M) (C)	RV-7FRL (M) (C)	RV-7FRL (M) (C)
Environmental specifications		Standard/ Oil mist/ Cleanroom		
Protection degree		IP40 (standard)/ IP67 (oil mist) *1/ ISO class3 *7		
Installation		Floor type, ceiling type, (wall-mounted type *2)		
Structure		Vertical multiple-joint type		
Degrees of freedom		6		
Drive system		AC servo motor		
Position detection method		Absolute encoder		
Maximum load capacity	kg	Maximum 7 (Rated 7) *8		
Arm length	mm	340+370	435+470	565+805
Maximum reach radius	mm	713	908	1503
Operating range	J1	480 ( $\pm 240$ )		380 ( $\pm 190$ )
	J2	240 (-115 to +125)	240 (-110 to +130)	240 (-90 to +150)
	J3	156 (-0 to +156)	162 (-0 to +162)	167.5 (-10 to +157.5)
	J4	400 ( $\pm 200$ )		
	J5	240 ( $\pm 120$ )		
	J6	720 ( $\pm 360$ )		
Maximum speed	J1	360	288	234
	J2	401	321	164
	J3	450	360	219
	J4	337		
	J5	450		
	J6	720		
Maximum composite speed *3	mm/sec	11064	10977	15300
Cycle time *4	sec	0.32	0.35	0.63
Position repeatability	mm		$\pm 0.02$	$\pm 0.06$
Ambient temperature	$^\circ\text{C}$		0 to 40	
Mass	kg	65	67	130
Tolerable moment	J4	16.2		
	J5	16.2		
	J6	6.86		
Tolerable amount of inertia	J4	0.45		
	J5	0.45		
	J6	0.10		
Tool wiring		Gripper: 8 input points/8 output points, Signal cable for the multi-function gripper and sensors, LAN x 1 <100 BASE-TX> *5		
Tool pneumatic pipes		Primary: $\Phi 6 \times 2$ Secondary: $\Phi 4 \times 8, \Phi 4 \times 4$ (from base portion to forearm)		
Machine cable		5m (connector on both ends)		
Connected controller *6		CR800-D, CR800-R, CR800-Q		

\*1: Please contact Mitsubishi Electric dealer since the environmental resistance may not be secured depending on the characteristics of oil you use.

\*2: The wall-mounted specification is a custom specification where the operating range of the J1-axis is limited.

\*3: This is the value at the surface of the mechanical interface when all axes are composited.

\*4: Value for a 25mm up/down and 300mm horizontal reciprocal movement with 1kg. The cycle time is the value for RV-7FR-R, RV-7FRL-R, RV-7FRL-R.

\*5: Can also be used as a spare line (0.13 sq. mm, 4-pair cable) for conventional models.

\*6: Select either controller according to your application. CR800-D: Standalone type, CR800-R: MELSEC iQ-R compatible type, CR800-Q: MELSEC Q Series compatible type.

\*7: Preservation of cleanliness levels depends on conditions of a downstream flow of 0.3 m/s in the cleanroom and internal robot suctioning. A  $\Phi 8$ -mm coupler for suctioning is provided at the back of the base.

\*8: The maximum load capacity indicates the maximum payload when the mechanical interface is facing downward ( $\pm 10^\circ$  to the perpendicular).



► External Dimensions/Operating Range Diagram

**RV-7FR**

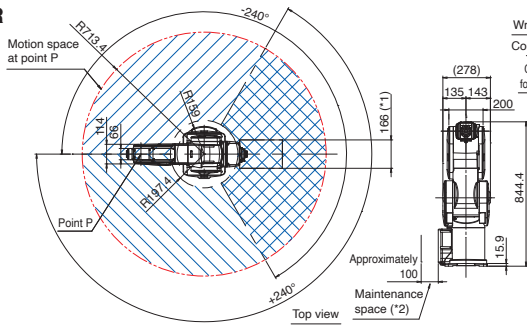

Notes  
 \*1. Make sure to leave enough space open for cable connections between devices.  
 \*2. Make sure to leave enough space open for removing and attaching covers during maintenance work.  
 \*3. Specify a thread engagement length of 7.5 to 8 mm.

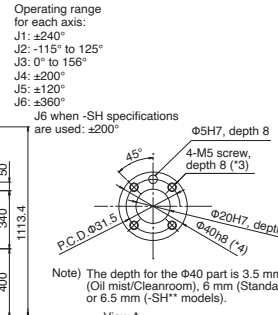
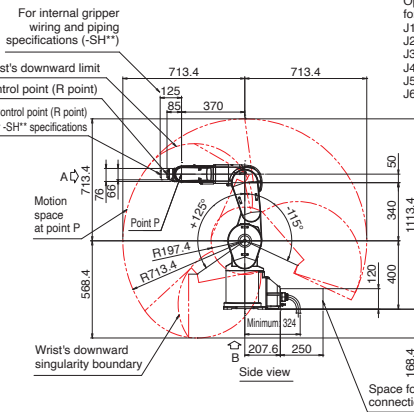

**RV-7FRL**

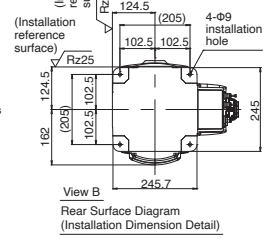
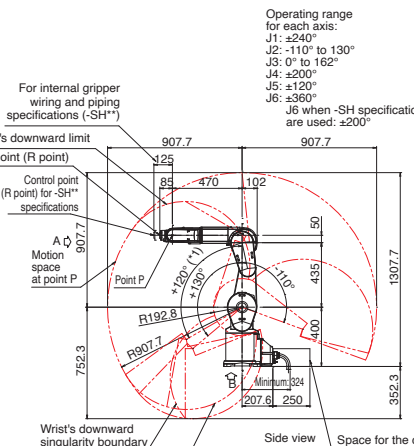
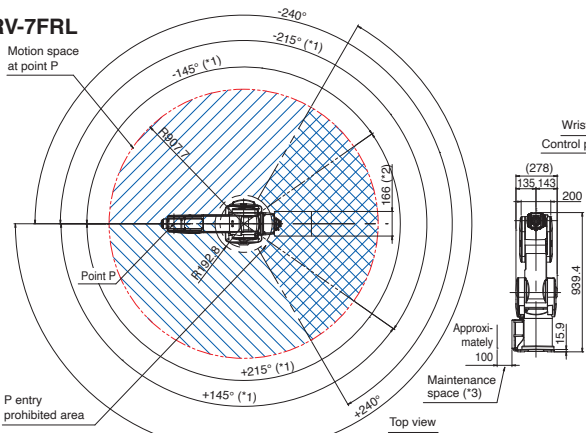

**Dedicated for RV-7FRL**

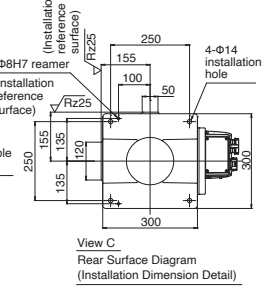

**RV-7FRL**

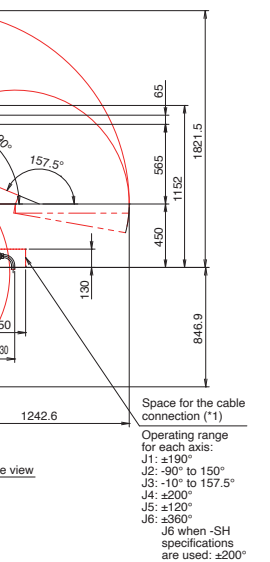
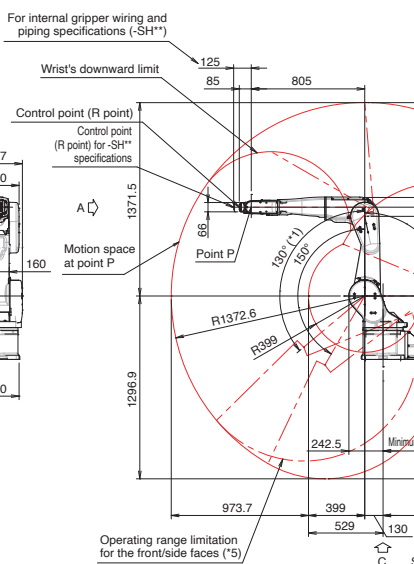
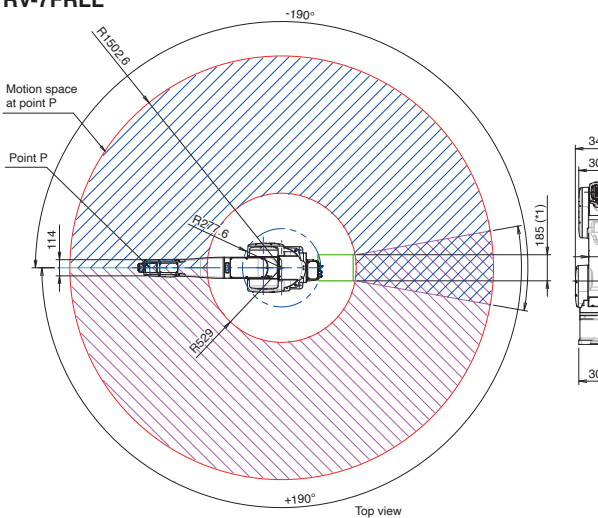

\*1. Make sure to leave enough space open for cable connections between devices.  
 \*2. Make sure to leave enough space open for removing and attaching covers during maintenance work.  
 \*3. Specify a thread engagement length of 7.5 to 8 mm.  
 \*4. Limits on the operating range for the front part: When the J1-axis angle is inside the range of +145° ≤ J1 ≤ +215° or -145° ≤ J1 ≤ -215°, the operating range of the J2-axis is limited to -110° ≤ J2 ≤ +120°.  
 \*5. Limits on the operating range for the front part: When the J1-axis angle is inside the range of J1 ≥ +120° or J1 ≤ -120°, the operating range of the J2-axis is limited to -90° ≤ J2 ≤ +130°.  
 \*6. Refer to the standard specification manual for detailed specification of -SH.

► Mounting cable specifications (\*1)

Devices that can be mounted	Model (machine no.)				
	-SH01	-SH02	-SH03	-SH04	-SH05
Air Ø4	○ (x4)	-	-	○ (x2)	○ (x2)
Gripper input 8 points	○	○	-	○	○
Vision sensor	-	○	○	-	○
Force sensor	-	○	○	○	-
Electric gripper	-	(may be used for either device)	○	-	-

\*1) The J6 axis range of motion is ±200deg. Protection level is IP40.

**RV-7FRL -D-**

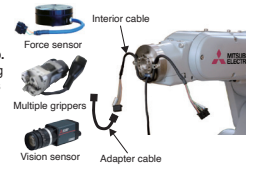
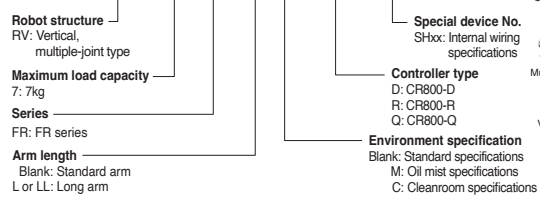

# MELFA RV-13FR RV-13FRL

## Vertical 13kg type

### RV-13FR RV-13FRL

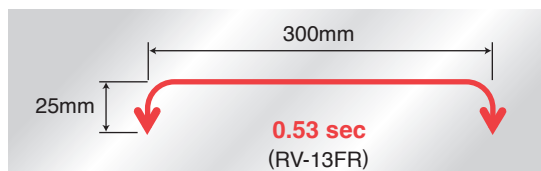

Cutting-edge servo control and optimized arm construction provide extremely fast and precise heavy-duty operation. Optimized arm length and 6 joints for a broader range of movement support a wide range of layouts. Designed to withstand environmental conditions, it can be used in a wide range of applications without having to worry about the installation environment. Suitable for various types of work, such as transporting mechanical parts, assembling electrical components and even packaging products such as pharmaceuticals and foodstuffs.

- Among the fastest moving robots in its class  
[Max. composite speed: 10.5 m/s (RV-13FR)]
- Standard cycle time [0.53 s (RV-13FR)]
- Pivotal operating range:  $\pm 190^\circ$
- Environmental specifications  
[standard: IP40; oil mist: IP67; cleanroom: ISO class 3]
- Standards compliance  
Compliant with European Machinery Directives (CE) as standard.  
Compliance with other standards is available in specialized machines.  
Contact Mitsubishi Electric for details.

### Specifications

Item	Unit	RV-13FR (M) (C)	RV-13FRL (M) (C)
Environmental specifications		Standard/ Oil mist/ Cleanroom	
Protection degree		IP40 (standard)/ IP67 (oil mist) *1/ ISO class3 *7	
Installation		Floor type, ceiling type, (wall-mounted type *2)	
Structure		Vertical, multiple-joint type	
Degrees of freedom		6	
Drive system		AC servo motor	
Position detection method		Absolute encoder	
Maximum load capacity	kg	Maximum 13 (Rated 12) *8	
Arm length	mm	410+550	565+690
Maximum reach radius	mm	1094	1388
Operating range	J1	380 ( $\pm 190$ )	
	J2	240 (-90 to +150)	
	J3	167.5 (-10 to +157.5)	
	J4	400 ( $\pm 200$ )	
	J5	240 ( $\pm 120$ )	
	J6	720 ( $\pm 360$ )	
Maximum speed	J1	290	234
	J2	234	164
	J3	312	219
	J4	375	375
	J5	375	375
	J6	720	720
Maximum composite speed *3	mm/sec	10450	9700
Cycle time *4	sec	0.53	0.68
Position repeatability	mm	$\pm 0.05$	
Ambient temperature	$^\circ\text{C}$	0 to 40	
Mass	kg	120	130
Tolerable moment	J4	19.3	
	J5	19.3	
	J6	11	
Tolerable amount of inertia	J4	0.47	
	J5	0.47	
	J6	0.14	
Tool wiring		Gripper: 8 input points/8 output points Signal cable for the multi-function gripper and sensors LAN x 1 <100 BASE-TX> *5	
Tool pneumatic pipes		Primary: $\Phi 6 \times 2$ Secondary: $\Phi 6 \times 8, \Phi 4 \times 4$ (from base portion to forearm)	
Machine cable		5m (connector on both ends)	
Connected controller *6		CR800-D, CR800-R, CR800-Q	

▶ **External Dimensions/Operating Range Diagram**

**RV-13FR**

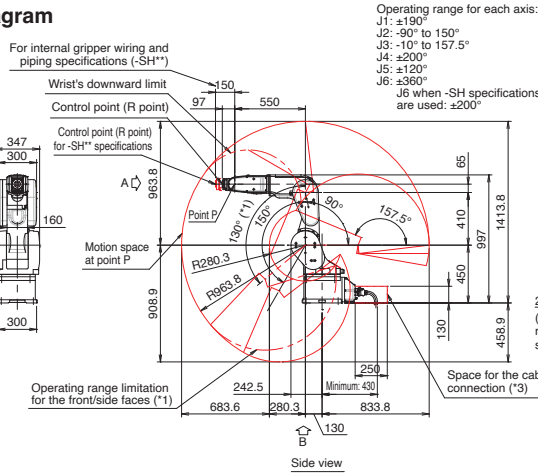
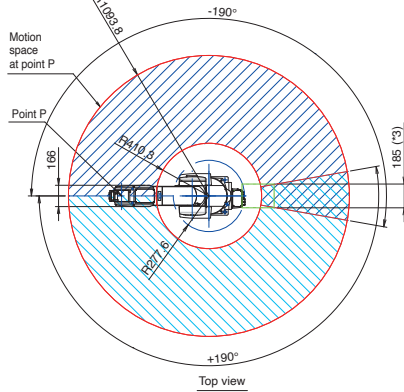

**Shared parts**

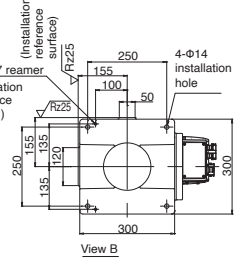
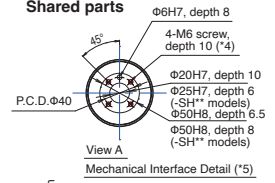

**RV-13FRL**

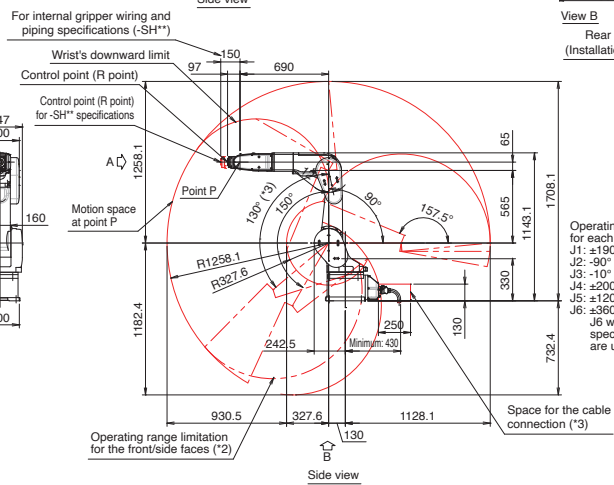
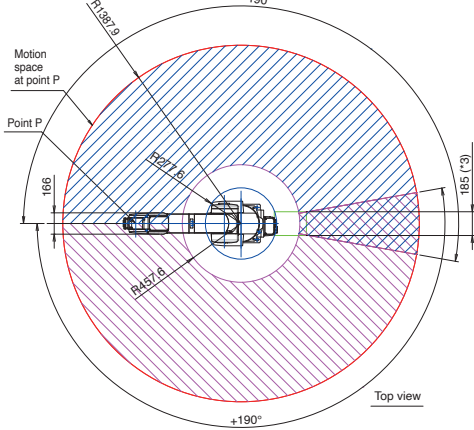

\*1: Operating range for the front and side parts: When the J1-axis angle is inside the range of  $J1 \geq +120^\circ$  or  $J1 \leq -130^\circ$ , the operating range of the J2-axis is limited to  $-90^\circ \leq J2 \leq +130^\circ$ .  
 \*2: Make sure to leave enough space open for cable connections between devices.  
 \*3: Specify a thread engagement length of 10 to 9mm.  
 \*4: Refer to the standard specification manual for detailed specification of -SH.  
 \*5: Please refer to the standard specification for detailed specifications of the -SH models.

▶ **Mounting cable specifications (\*1)**

Devices that can be mounted	Model (machine no.)				
	-SH01	-SH02	-SH03	-SH04	-SH05
Air $\Phi 4$	○ (x4)	-	-	○ (x2)	○ (x2)
Gripper input 8 points	○	○	-	○	○
Vision sensor	-	○	○	○	○
Force sensor	-	○	○	○	-
Electric gripper	-	(may be used for either device)	○	-	-

\*1) The J6 axis range of motion is  $\pm 200$ deg. Protection level is IP40.

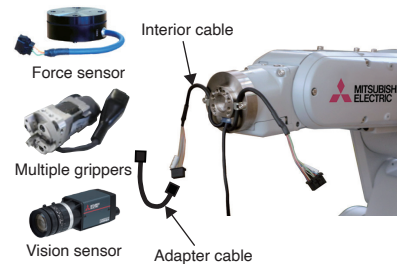

**RV-13FRL-D-**

**Robot structure**  
RV: Vertical, multiple-joint type

**Maximum load capacity**  
13: 13kg

**Series**  
FR: FR series

**Arm length**  
Blank: Standard arm  
L: Long arm

**Special device No.**  
SHxx: Internal wiring specifications

**Controller type**  
D: CR800-D  
R: CR800-R  
Q: CR800-Q

**Environment specification**  
Blank: Standard specifications  
M: Oil mist specifications  
C: Cleanroom specifications

\*1: Please contact Mitsubishi Electric dealer since the environmental resistance may not be secured depending on the characteristics of oil you use.  
 \*2: The wall-mounted specification is a custom specification where the operating range of the J1-axis is limited.  
 \*3: This is the value at the surface of the mechanical interface when all axes are composited.  
 \*4: Value for a 25mm up/down and 300mm horizontal reciprocal movement with 5kg load. The cycle time is the value for RV-13FR-R and RV-13FRL-R.  
 \*5: Can also be used as a spare line (0.13 sq. mm, 4-pair cable) for conventional models. Provided up to the inside of the forearm.  
 \*6: Select either controller according to your application. CR800-D: Standalone type, CR800-R: MELSEC iQ-R compatible type, CR800-Q: MELSEC Q Series compatible type.  
 \*7: Preservation of cleanliness levels depends on conditions of a downstream flow of 0.3 m/s in the cleanroom and internal robot suctioning. A  $\Phi 8$ -mm coupler for suctioning is provided at the back of the base.  
 \*8: The maximum load capacity indicates the maximum payload when the mechanical interface is facing downward ( $\pm 10^\circ$  to the perpendicular).

# MELFA RV-20FR

## Vertical 20kg type

### RV-20FR



Cutting-edge servo control and optimized arm construction provide extremely portable and precise heavy-duty operation. Optimized arm length and 6 joints for a broader range of movement support a wide range of layouts. Designed to withstand environmental conditions, it can be used in a wide range of applications without having to worry about the installation environment. Plenty of scope for using multiple grippers or multi-function grippers and capable of handling work such as transporting high-load mechanical parts, assembling electrical components and packaging pharmaceutical products.

- Standard cycle time [0.7 s]
- Pivotal operating range:  $\pm 190^\circ$
- Environmental specifications  
[standard: IP40; oil mist: IP67; cleanroom: ISO class 3]
- Standards compliance  
Compliant with European Machinery Directives (CE) as standard.  
Compliance with other standards is available in specialized machines.  
Contact Mitsubishi Electric for details.

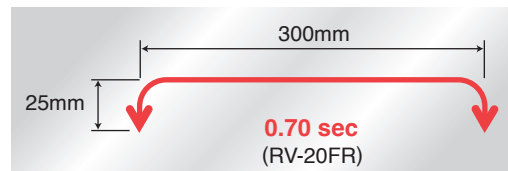

### ► Specifications

Item	Unit	RV-20FR (M) (C)
Environmental specifications		Standard/ Oil mist/ Cleanroom
Protection degree		IP40 (standard)/ IP67 (oil mist) *1/ ISO class3 *7
Installation		Floor type, ceiling type, (wall-mounted type *2)
Structure		Vertical multiple-joint type
Degrees of freedom		6
Drive system		AC servo motor
Position detection method		Absolute encoder
Maximum load capacity	kg	Maximum 20 (Rated 15) *8
Arm length	mm	410+550
Maximum reach radius	mm	1094
Operating range	J1	380 ( $\pm 190$ )
	J2	240 (-90 to +150)
	J3	167.5 (-10 to +157.5)
	J4	400 ( $\pm 200$ )
	J5	240 ( $\pm 120$ )
	J6	720 ( $\pm 360$ )
Maximum speed	J1	110
	J2	110
	J3	110
	J4	124
	J5	125
	J6	360
Maximum composite speed *3	mm/sec	4200
Cycle time *4	sec	0.70
Position repeatability	mm	$\pm 0.05$
Ambient temperature	$^\circ\text{C}$	0 to 40
Mass	kg	120
Tolerable moment	J4	49.0
	J5	49.0
	J6	11
Tolerable amount of inertia	J4	1.40
	J5	1.40
	J6	0.14
Tool wiring		Gripper: 8 input points/8 output points Signal cable for the multi-function gripper and sensors LAN x 1 <100 BASE-TX> *5
Tool pneumatic pipes		Primary: $\Phi 6 \times 2$ Secondary: $\Phi 6 \times 8, \Phi 4 \times 4$ (from base portion to forearm)
Machine cable		5m (connector on both ends)
Connected controller *6		CR800-D, CR800-R, CR800-Q

▶ External Dimensions/Operating Range Diagram

**RV-20FR**

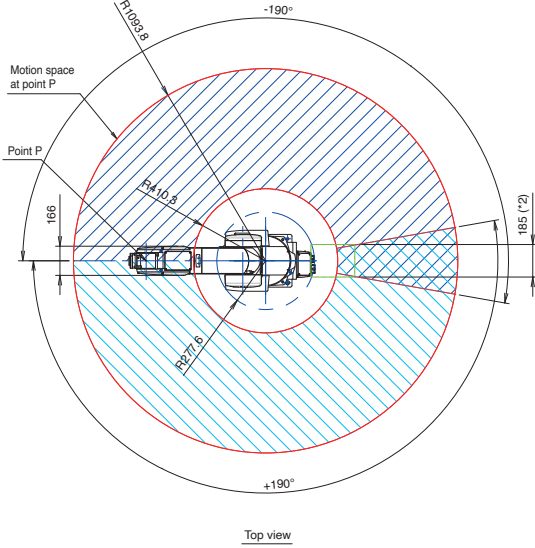

Top view

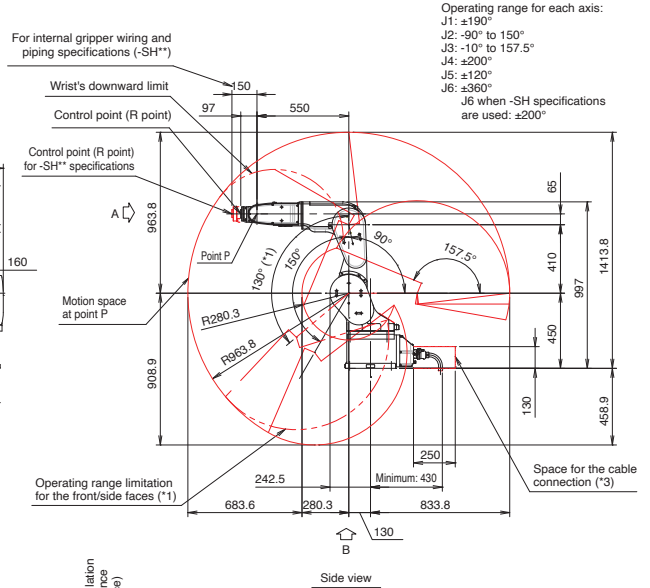

Side view

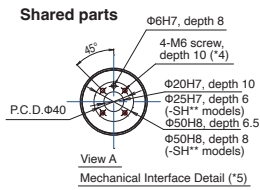

Mechanical Interface Detail (\*5)

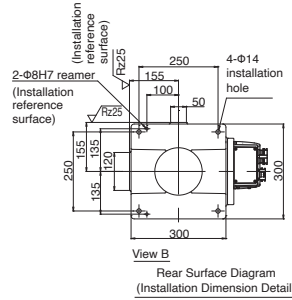

Rear Surface Diagram (Installation Dimension Detail)

\*1: Operating range for the front and side parts: When the J1-axis angle is inside the range of  $J1 \geq +120^\circ$  or  $J1 \leq -130^\circ$ , the operating range of the J2-axis is limited to  $-90^\circ \leq J2 \leq +130^\circ$ .  
 \*2: Make sure to leave enough space open for cable connections between devices.  
 \*3: Specify a thread engagement length of 10 to 9mm.  
 \*4: Refer to the standard specification manual for detailed specification of -SH.

▶ Mounting cable specifications (\*1)

Devices that can be mounted	Model (machine no.)				
	-SH01	-SH02	-SH03	-SH04	-SH05
Air Φ4	○ (x4)	-	-	○ (x2)	○ (x2)
Gripper input 8 points	○	○	○	○	○
Vision sensor	-	○	○	○	○
Force sensor	-	○	○	○	-
Electric gripper	-	(may be used for either device)	○	-	-

\*1) The J6 axis range of motion is  $\pm 200$ deg. Protection level is IP40.

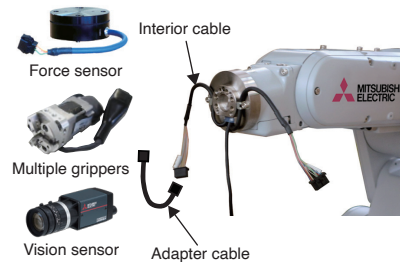

**RV-20FR** - **D** -

**Robot structure**  
RV: Vertical, multiple-joint type

**Maximum load capacity**  
20: 20kg

**Series**  
FR: FR series

**Special device No.**  
SHxx: Internal wiring specifications

**Controller type**  
D: CR800-D  
R: CR800-R  
Q: CR800-Q

**Environment specification**  
Blank: Standard specifications  
M: Oil mist specifications  
C: Cleanroom specifications

\*1: Please contact Mitsubishi Electric dealer since the environmental resistance may not be secured depending on the characteristics of oil you use.  
 \*2: The wall-mounted specification is a custom specification where the operating range of the J1-axis is limited.  
 \*3: This is the value at the surface of the mechanical interface when all axes are composited.  
 \*4: Value for a 25mm up/down and 300mm horizontal reciprocal movement with 5kg load. The cycle time is the value for RV-20FR-R.  
 \*5: Can also be used as a spare line (0.13 sq. mm, 4-pair cable) for conventional models. Provided up to the inside of the forearm.  
 \*6: Select either controller according to your application. CR800-D: Standalone type, CR800-R: MELSEC iQ-R compatible type, CR800-Q: MELSEC Q Series compatible type.  
 \*7: Preservation of cleanliness levels depends on conditions of a downstream flow of 0.3 m/s in the cleanroom and internal robot suctioning. A Φ8-mm coupler for suctioning is provided at the back of the base.  
 \*8: The maximum load capacity indicates the maximum payload when the mechanical interface is facing downward ( $\pm 10^\circ$  to the perpendicular).

**MELFA**  
**RV-35FR**  
**RV-50FR**  
**RV-80FR**

**Vertical**  
**35/50/80kg**  
**type**

**RV-35FR**  
**RV-50FR**  
**RV-80FR**

It is ideal for handling large workpieces and heavy objects such as processing machine LD/ULD applications, packing processes, and palletizing processes.

▪ **FR series maximum reach and maximum payload**

Maximum reach :2100mm,payload:35/50/80kg.

▪ **Manage the entire line with a sequencer**

Compatible with the iQ Platform.

Easy linkage with sequencers realizes comprehensive management of the entire line and wiring saving.

▪ **Improvement of safety for collaborative applications**

Functional safety compatible. Realize collaborative work with people and eliminate safety fences.

We support safe and highly efficient line construction.



► **Specifications**

Item		Unit	RV-35FR	RV-50FR	RV-80FR
Environmental specifications			Standard/ Oil mist		
Protection degree			Wrist equivalent to IP67,Body equivalent to IP65(standard) Whole body equivalent to IP67(oil mist)		
Installation			Floor type		
Structure			Vertical multiple-joint type		
Degrees of freedom			6		
Drive system			AC servo motor		
Position detection method			Absolute encoder		
Maximum load capacity		kg	35	50	80
Arm length		mm	870+1080		
Maximum reach radius		mm	2100		
Operating range	J1	deg	360 (±180)		
	J2		245 (-105~140)		
	J3		290 (-135~155)		
	J4		720 (±360)		
	J5		290 (±145)		
	J6		900 (±450)		
Maximum speed*1	J1	deg/sec	180	180	180
	J2		180	180	180
	J3		185	185	160
	J4		260	260	185
	J5		260	260	165
	J6		360	360	280
Maximum composite speed*2		mm/sec	13400	13400	12700
Position repeatability		mm	±0.06		
Ambient temperature		°C	0 to 45		
Mass		kg	560		
Tolerable moment	J4	Nm	210	210	336
	J5		210	210	336
	J6		130	130	194
Tolerable amount of inertia	J4	kgm <sup>2</sup>	19.6	28	34
	J5		19.6	28	34
	J6		7.7	11	13.7
Tool wiring			12 input points/8 output points LAN x 1 <Category 5e-compliant>		
Tool pneumatic pipes			Φ10×2		
Connected controller			CR860-D/CR860-R/CR860-Q		

\*1 Values in the table indicate the maximum speed, and the actual speed of each axis varies depending on factors such as the posture, load, and the amount of movement.

\*2 This is the value at the center point of the mechanical interface when all axes are combined. The value is a theoretical value calculated from the maximum speed of each joint.

▶ **External Dimensions/Operating Range Diagram**  
**RV-35FR/50FR/80FR**

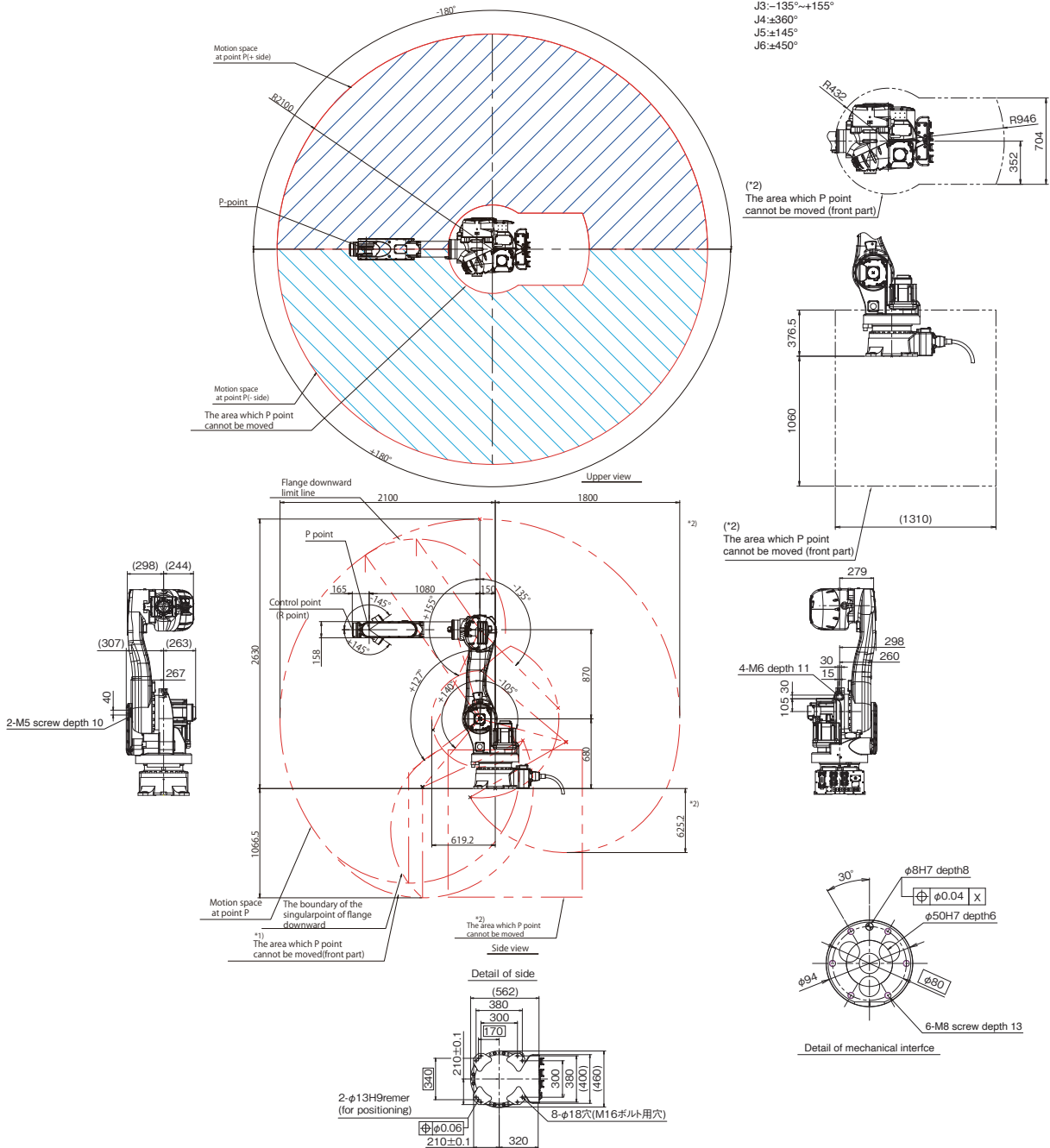

1. The posture of side view  
The following figure shown a robot at the position of: J1=0°, J2=0°, J3=90°, J4=0°, J5=0°, J6=0°
2. \*1) Rear face operating limit: When the J axis angle is J1 <= -137° or +137° <= J1, the J2 axis operation is limited to J2 <= +127°
3. \*2) The area which P point cannot be moved: P point cannot move to this area. This limitation is valid at factory shipping, but it can be released by parameter MELTEXS.

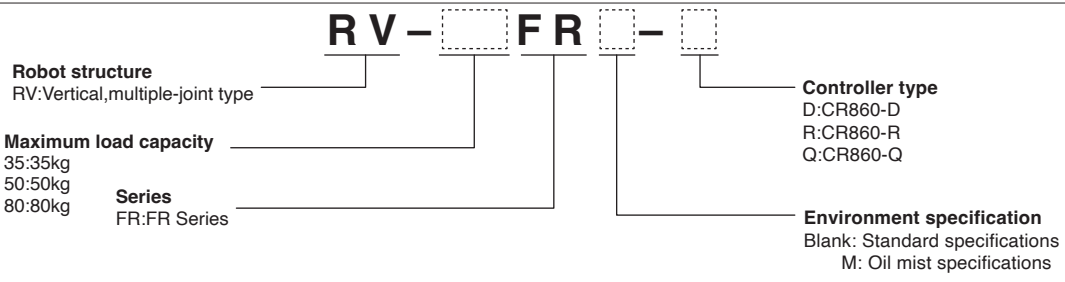

**MELFA**  
**RH-6FRH35**  
**RH-6FRH45**  
**RH-6FRH55**

**Horizontal**  
**6kg**  
**type**

A horizontal, multiple-joint type robot with highly rigid arms and cutting-edge servo controls to provide extremely fast and precise heavy-duty operation. Ideal for a wide range of fields, from transportation of small components that demands high-speed operation through to assembly work where excellent precision is required.

- Among the fastest moving robots in its class  
 [XY composite: 8,300 mm/s]  
 [J4 ( $\theta$  axis): 2,400 deg/s]
- Standard cycle time  
 [0.29 s (RH-6FRH55)]
- Pivotal operating range:  $\pm 170^\circ$
- Environmental specifications  
 [standard: IP20; oil mist: IP65; cleanroom: ISO class 3]
- Standards compliance  
 Compliant with European Machinery Directives (CE) as standard.  
 Compliance with other standards is available in specialized machines.  
 Contact Mitsubishi Electric for details.

**RH-6FRH35**  
**RH-6FRH45**  
**RH-6FRH55**

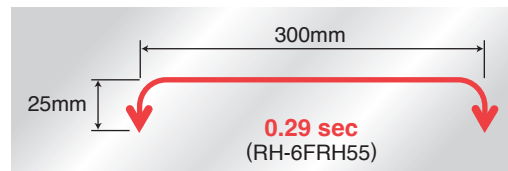

► **Specifications**

Item	Unit	RH-6FRH35XX/M/C	RH-6FRH45XX/M/C	RH-6FRH55XX/M/C
Environmental specifications			Standard/ Oil mist/ Cleanroom	
Protection degree *1			IP20/IP65 *6, ISO class3 *7	
Installation			Floor type	
Structure			Horizontal multiple-joint type	
Degrees of freedom			4	
Drive system			AC servo motor	
Position detection method			Absolute encoder	
Maximum load capacity	kg		Maximum 6 (Rated 3)	
Arm length	NO1 arm	mm	125	225
	NO2 arm	mm		225
Maximum reach radius	mm	350	450	550
Operating range	J1	deg	340 ( $\pm 170$ )	
	J2	deg	290 ( $\pm 145$ )	
	J3 (Z)	mm	xx=20:200, xx=34:340	
	J4 ( $\theta$ )	deg	720 ( $\pm 360$ )	
Maximum speed	J1	deg/sec	400	
	J2	deg/sec	670	
	J3 (Z)	mm/sec	2400	
	J4 ( $\theta$ )	deg/sec	2500	
Maximum composite speed *2	mm/sec	6900	7600	8300
Cycle time *3	sec		0.29	
Position repeatability	Y-X composite	mm	$\pm 0.010$	$\pm 0.010$
	J3 (Z)	mm		$\pm 0.01$
	J4 ( $\theta$ )	deg		$\pm 0.004$
Ambient temperature	$^\circ\text{C}$		0 to 40	
Mass	kg	36	36	37
Tolerable amount of inertia	Rating		0.01	
	Maximum		0.12	
Tool wiring			Gripper: 8 input points/8 output points Signal cable for the multi-function gripper LAN x 1 <100 BASE-TX> *4	
Tool pneumatic pipes			Primary: $\phi 6 \times 2$ Secondary: $\phi 4 \times 8$	
Machine cable			5m (connector on both ends)	
Connected controller *5			CR800-D, CR800-R, CR800-Q	



▶ External Dimensions/Operating Range Diagram

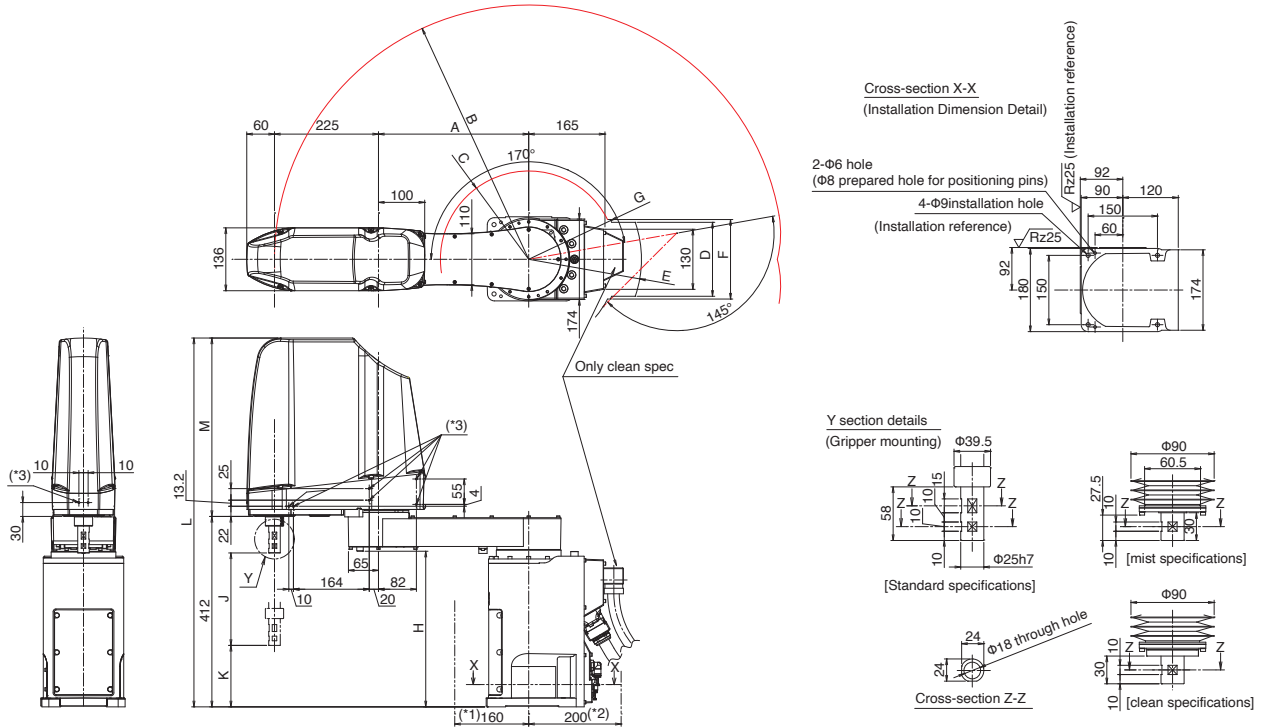

- \*1: Space required for the battery replacement
- \*2: Space required for the interconnection cable
- \*3: Screw holes (M4, 6 mm long) for affixing user wiring and piping. (6 locations on both sides and 2 locations on the front of the No. 2 arm.)

**Variable dimensions**

Robot series	A	B	C	D	E	F	G	H	J	K	L	M
RH-6FRH3520	125	R350	R142	210	R253	220	R174	342	200	133	798	386
RH-6FRH3520M/C	125	R350	R142	224	R253	268	R196	342	200	133	798	386
RH-6FRH3534	125	R350	R142	210	R253	220	R174	342	340	-7	938	526
RH-6FRH3534M/C	125	R350	R142	224	R253	268	R196	342	340	-43	938	526
RH-6FRH4520	225	R450	R135	210	R253	220	R174	337	200	133	798	386
RH-6FRH4520M/C	225	R450	R135	224	R253	268	R197	337	200	133	798	386
RH-6FRH4534	225	R450	R135	210	R253	220	R174	337	340	-7	938	526
RH-6FRH4534M/C	225	R450	R135	224	R253	268	R197	337	340	-43	938	526
RH-6FRH5520	325	R550	R191	160	R244	172	R197	337	200	133	798	386
RH-6FRH5520C	325	R550	R191	160	R253	259	R222	337	200	133	798	386
RH-6FRH5520M	325	R550	R191	160	R244	259	R222	337	200	133	798	386
RH-6FRH5534	325	R550	R191	160	R244	172	R197	337	340	-7	938	526
RH-6FRH5534C	325	R550	R191	160	R253	259	R222	337	340	-43	938	526
RH-6FRH5534M	325	R550	R191	160	R244	259	R222	337	340	-43	938	526

**RH-6FRH5520-D**

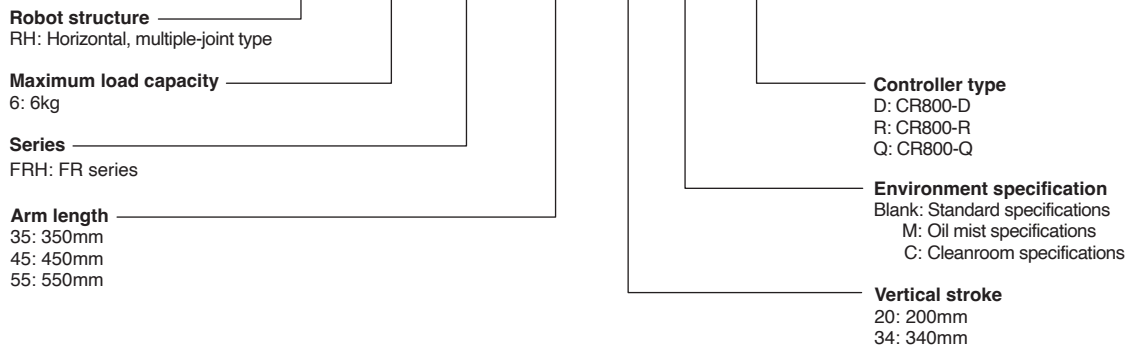

\*1: The environmental resistance specifications (M: Oil mist specifications, C: Cleanroom specifications) for the RH-6FRH is factory-set custom specifications.  
 \*2: At the maximum speed on the X-Y flat surface in the robot's control point, it is obtained with each speed of J1, J2, and J4. The control point is the position offset by the rated inertia from the flange.  
 \*3: Value for a maximum load capacity of 2 kg. The cycle time may increase if specific requirements apply such as high work positioning accuracy, or depending on the operating position.  
 (The cycle time is based on back-and-forth movement over a vertical distance of 25 mm and horizontal distance of 300 mm.)  
 \*4: Can also be used as a spare line (0.2 sq. mm, 4-pair cable) for conventional models.  
 \*5: Select either controller according to your application. CR800-D: Standalone type, CR800-R: MELSEC iQ-R compatible type, CR800-Q: MELSEC Q Series compatible type.  
 \*6: Please contact Mitsubishi Electric dealer since the environmental resistance may not be secured depending on the characteristics of oil you use. Direct jet to the bellows is excluded.  
 \*7: Preservation of cleanliness levels depends on conditions of a downstream flow of 0.3 m/s in the cleanroom and internal robot suctioning. A Φ8-mm coupler for suctioning is provided at the back of the base.

**MELFA**  
**RH-12FRH55**  
**RH-12FRH70**  
**RH-12FRH85**  
**RH-20FRH85**  
**RH-20FRH100**

**Horizontal**  
**12/20kg**  
**type**

**RH-12FRH55**  
**RH-12FRH70**  
**RH-12FRH85**  
**RH-20FRH85**  
**RH-20FRH100**

A horizontal, multiple-joint type robot with highly rigid arms and cutting-edge servo controls to provide extremely fast and precise heavy-duty operation. Enhancements to the wrist axis also mean that the robot has ample scope for handling multi-function grippers and offset grippers. Ideal for assembly and palletizing work.

- Among the fastest moving robots in its class  
 [XY composite: 13,283 mm/s (RH-20FRH)]  
 [J4 ( $\theta$  axis): 2,400 deg/s (RH-12FRH)]
- Standard cycle time  
 [0.30 s (RH-12FRH85)]
- Pivotal operating range:  $\pm 170^\circ$
- Environmental specifications  
 [standard, Oil mist: IP65; cleanroom: ISO class 3]
- Standards compliance  
 Compliant with European Machinery Directives (CE) as standard.  
 Compliance with other standards is available in specialized machines.  
 Contact Mitsubishi Electric for details.



### Specifications

Item	Unit	RH-12FRH55XX/M/C	RH-12FRH70XX/M/C	RH-12FRH85XX/M/C	RH-20FRH85XX/M/C	RH-20FRH100XX/M/C
Environmental specifications		Standard/ Oil mist/ Cleanroom			Standard/ Oil mist/ Cleanroom	
Protection degree *1		IP20/ IP65 *6/ ISO class 3 *7			IP20/ IP65 *6/ ISO class 3 *7	
Installation		Floor type			Floor type	
Structure		Horizontal multiple-joint type				
Degrees of freedom		4				
Drive system		AC servo motor				
Position detection method		Absolute encoder				
Maximum load capacity	kg	Maximum 12 (Rated 3)			Maximum 20 (Rated 5)	
Arm length	NO1 arm	225	375	525	525	525
	NO2 arm		325		325	475
Maximum reach radius	mm	550	700	850	850	1000
Operating range	J1	340 ( $\pm 170$ )			340 ( $\pm 170$ )	
	J2	290 ( $\pm 145$ )			306 ( $\pm 153$ )	
	J3 (Z)	xx=35:350, xx=45:450				
	J4 ( $\theta$ )	720 ( $\pm 360$ )			720 ( $\pm 360$ )	
Maximum speed	J1	420			280	
	J2	450			450	
	J3 (Z)	2800			2400	
	J4 ( $\theta$ )	2400			1700	
Maximum composite speed *2	mm/sec	11435	12535	11350	11372	13283
Cycle time *3	sec	0.30	0.30	0.30	0.30	0.36
Position repeatability	Y-X composite	$\pm 0.012$	$\pm 0.015$	$\pm 0.015$	$\pm 0.015$	$\pm 0.02$
	J3 (Z)		$\pm 0.01$			$\pm 0.01$
	J4 ( $\theta$ )		$\pm 0.005$			$\pm 0.005$
Ambient temperature	$^\circ\text{C}$	0 to 40				
Mass	kg	65	67	69	75	77
Tolerable amount of inertia	Rating	0.025			0.065	
	Maximum	0.3			1.05	
Tool wiring		Gripper: 8 input points/8 output points Signal cable for the multi-function gripper LAN x 1 <100 BASE-TX> *4				
Tool pneumatic pipes		Primary: $\phi 6 \times 2$ Secondary: $\phi 6 \times 8$				
Machine cable		5m (connector on both ends)				
Connected controller *5		CR800-D, CR800-R, CR800-Q				

▶ External Dimensions/Operating Range Diagram

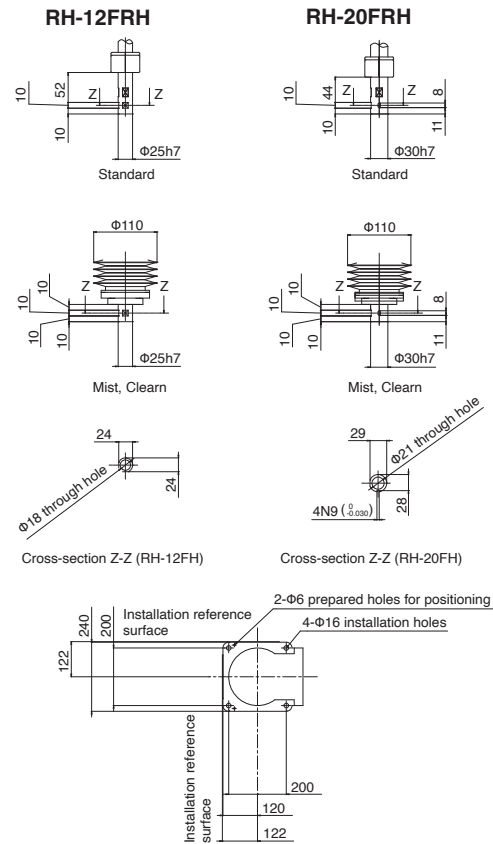
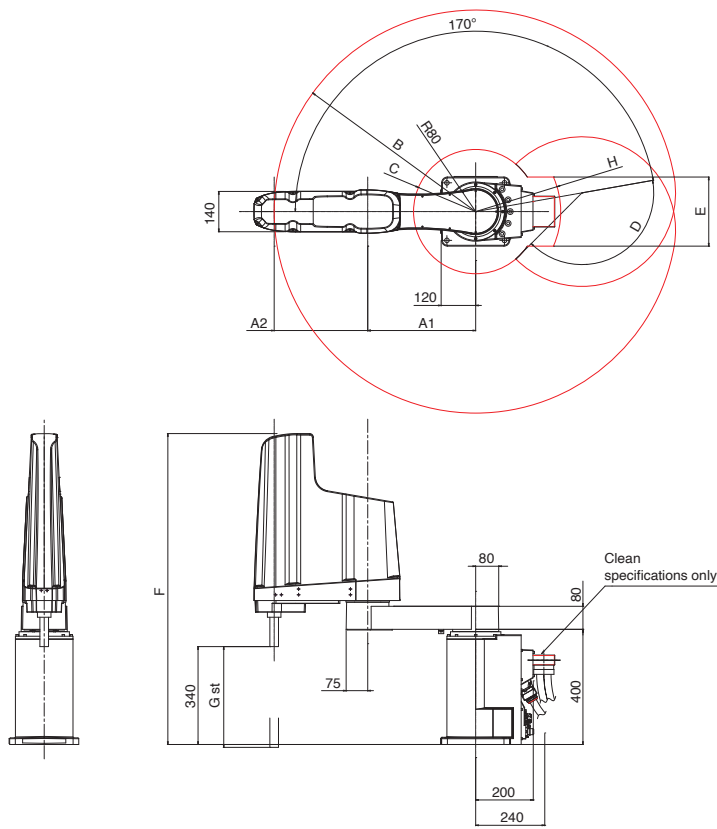

Variable dimensions

Robot series	A1	A2	B	C	D	E	F	G	H
RH-12FRH55xx	225	325	R550	R191	145°	240	1080/1180	350/450	R295
RH-12FRH55xxM/C	225	325	R550	R191	145°	320	1080/1180	350/450	R382
RH-12FRH70xx	375	325	R700	R216	145°	240	1080/1180	350/450	R295
RH-12FRH70xxM/C	375	325	R700	R216	145°	320	1080/1180	350/450	R382
RH-12FRH/20FHR85xx	525	325	R850	R278	153°	-	1080/1180	350/450	-
RH-12FRH/20FHR85xx4M/C	525	325	R850	R278	153°	240	1080/1180	350/450	R367
RH-20FRH100xx	525	475	R1000	R238	153°	240	1080/1180	350/450	R295
RH-20FRH100xxM/C	525	475	R1000	R238	153°	-	1080/1180	350/450	-

**RH-20FRH10045-D**

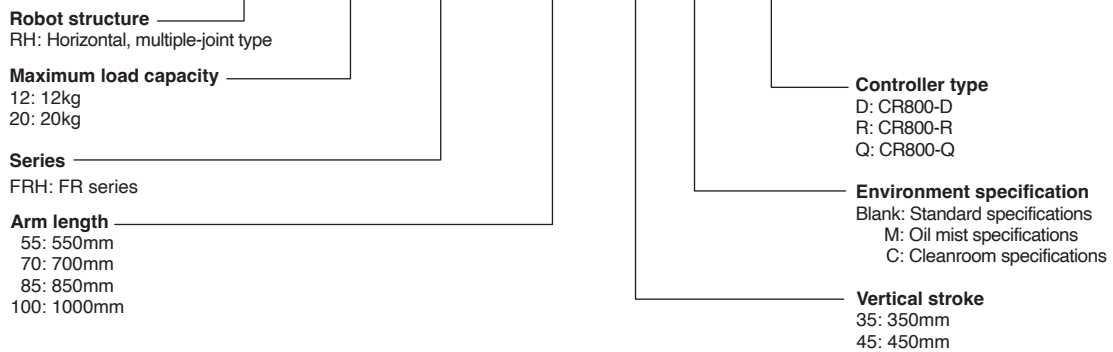

\*1: The environmental resistance specifications (M: Oil mist specifications, C: Cleanroom specifications) is factory-set custom specifications.  
 \*2: At the maximum speed on the X-Y flat surface in the robot's control point, it is obtained with each speed of J1, J2, and J4. The control point is the position offset by the rated inertia from the flange.  
 \*3: Value for a maximum load capacity of 2 kg. The cycle time may increase if specific requirements apply such as high work positioning accuracy, or depending on the operating position.  
 (The cycle time is based on back-and-forth movement over a vertical distance of 25 mm and horizontal distance of 300 mm.)  
 \*4: Can also be used as a spare line (0.2 sq. mm, 4-pair cable) for conventional models.  
 \*5: Select either controller according to your application. CR800-D: Standalone type, CR800-R: MELSEC iQ-R compatible type, CR800-Q: MELSEC Q Series compatible type.  
 \*6: Please contact Mitsubishi Electric dealer since the environmental resistance may not be secured depending on the characteristics of oil you use. Direct jet to the bellows is excluded.  
 \*7: Preservation of cleanliness levels depends on conditions of a downstream flow of 0.3 m/s in the cleanroom and internal robot suctioning. A Φ8-mm coupler for suctioning is provided at the back of the base.

# MELFA RH-3FRHR35

Ceiling  
mounted,  
horizontal  
3kg  
type

A horizontal, multiple-joint type robot with a space-saving suspended installation mode. Suitable for a wide range of applications, from precision assembly of electrical, electronic and other small components through to inspections, high-speed transportation and packaging.

- Among the fastest moving robots in its class  
[XY composite: 6,267 mm/s]  
[J4 ( $\theta$  axis): 3,146 deg/s]
- Standard cycle time  
[0.32 s (RH-3FRHR35)]
- Pivotal operating range:  $\pm 225^\circ$
- Environmental specifications  
[standard: IP20; cleanroom: ISO class 5; Waterproof: IP65]
- Standards compliance  
Compliant with European Machinery Directives (CE) as standard.  
Compliance with other standards is available in specialized machines.  
Contact Mitsubishi Electric for details.

## RH-3FRHR35

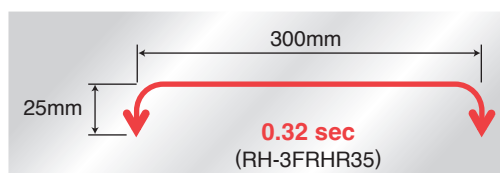

### Specifications

Item	Unit	RH-3FRHR3515	RH-3FRHR3512C	RH-3FRHR3512W
Environmental specifications		Standard	Cleanroom	Waterproof
Protection degree *1		IP20	ISOclass5 *5	IP65 *6
Installation		Ceiling type		
Structure		Horizontal multiple-joint type		
Degrees of freedom		4		
Drive system		AC servo motor		
Position detection method		Absolute encoder		
Maximum load capacity	kg	Maximum 3 (Rated 1)		
Arm length	NO1 arm	175		
	NO2 arm	175		
Maximum reach radius	mm	350		
Operating range	J1	450 ( $\pm 225$ )		
	J2	450 ( $\pm 225$ )		
	J3 (Z)	150	120	
	J4 ( $\theta$ )	1440 ( $\pm 720$ )		
Maximum speed	J1	672		
	J2	708		
	J3 (Z)	1500		
	J4 ( $\theta$ )	3146		
Maximum composite speed *2	mm/sec	6267		
Cycle time *3	sec	0.32		
Position repeatability	Y-X composite	$\pm 0.01$		
	J3 (Z)	$\pm 0.01$		
	J4 ( $\theta$ )	$\pm 0.01$		
Ambient temperature	$^\circ\text{C}$	0 to 40		
Mass	kg	24	28	
Tolerable amount of inertia	Rating	0.005		
	Maximum	0.05		
Tool wiring		Gripper: 8 input points (up to 4 points for shaft) / 8 output points, 8 spare lines		
Tool pneumatic pipes		Primary: $\Phi 6 \times 2$ Secondary: $\Phi 4 \times 8$		
Machine cable		5m (connector on both ends)		
Connected controller *4		CR800-D, CR800-R, CR800-Q		

► **External Dimensions/Operating Range Diagram**

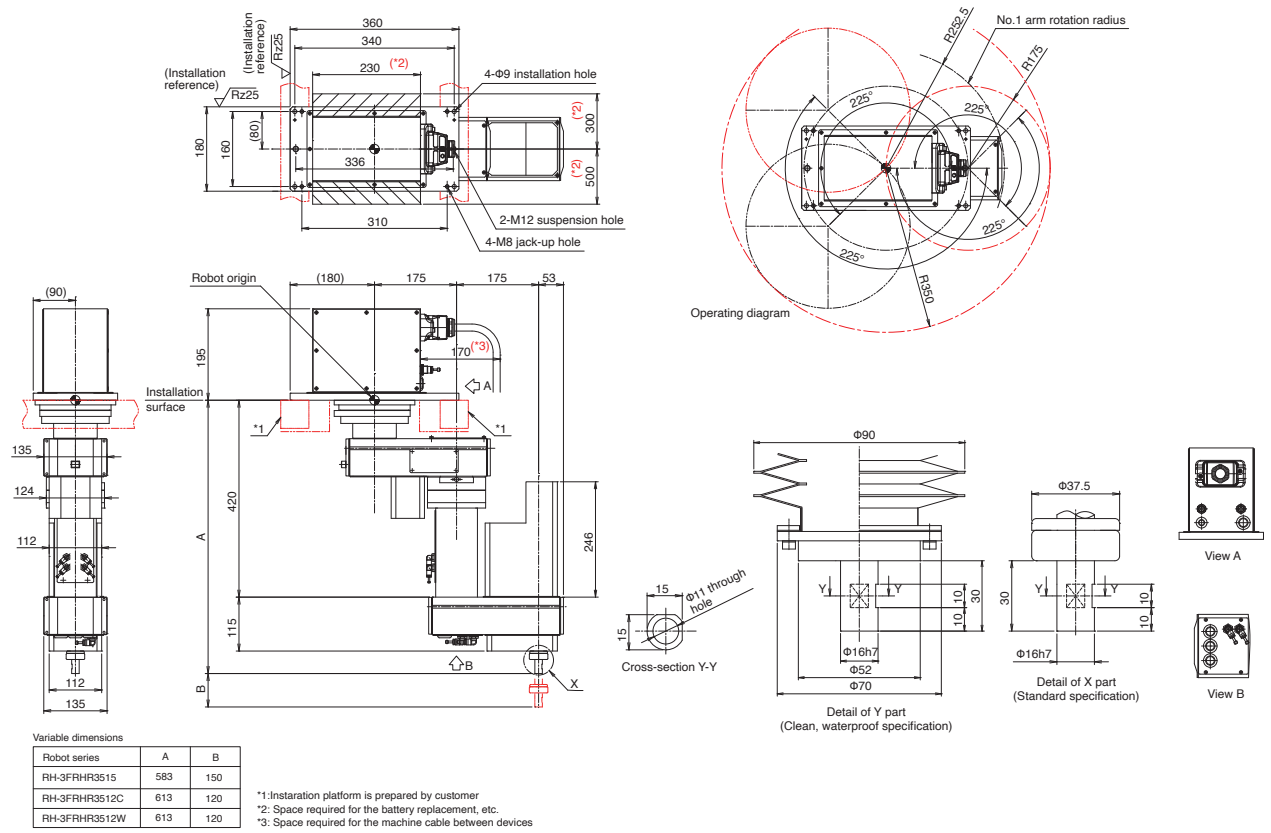

**Waterproof specification**

- IP65-rated and can be washed with water
  - Uses food-grade grease (NSF H1)\*1
  - Prevents any peeling of the coating (coating-free)
- \*1: Hygiene-related guidelines from the US NSF (National Sanitation Foundation)

**Cleanroom specification**

- ISO Class 5 cleanliness
  - Suitable for clean environments, such as transporting electrical/electronic components and pharmaceutical products.
  - Wiring and tubing can be installed internally in the tip.
- Prevents contamination produced by problems such as cable twisting or abrasion

► **Features**

**Reduced equipment space**

By suspending the machine from the ceiling, wasted space is eliminated and less space is needed for the entire installation.

**Easy installation and startup**

(1) Constructed so that it can be suspended from fittings installed on top of the ceiling joists, making installation simple.

(2) Internal gripper tubing channels are provided in the tip axis, making tube installation easy and eliminating the problem of tangled tubes. (Handles up to 4 inside the shaft.)

(3) When a compact system starts up that is contained within the robot's maximum range of movement, the cylindrical movement range limitation function can be used to ensure that robot movement does not extend beyond the specified cylindrical range, allowing startup adjustment to be made without having to worry about interference.

\*1: The environmental resistance specifications (C: Cleanroom specifications, W: Waterproof specifications) for the RH-3FRHR is factory-set custom specifications.  
\*2: At the maximum speed on the X-Y flat surface in the robot's control point, it is obtained with each speed of J1, J2, and J4. The control point is the position offset by the rated inertia from the flange.  
\*3: Value for a maximum load capacity of 1 kg. The cycle time may increase if specific requirements apply such as high work positioning accuracy, or depending on the operating position. (The cycle time is based on back-and-forth movement over a vertical distance of 25 mm and horizontal distance of 300 mm.)  
\*4: Select either controller according to your application. CR800-D: Standalone type, CR800-R: MELSEC iQ-R compatible type, CR800-Q: MELSEC Q Series compatible type.  
\*5: Preservation of cleanliness levels depends on conditions of a downstream flow of 0.3 m/s in the clean room and internal robot suctioning. A Ø8-mm coupler for suctioning is provided at the back of the base.  
\*6: Direct jet to the bellows is excluded.

**RH-3FRHR3512-D**

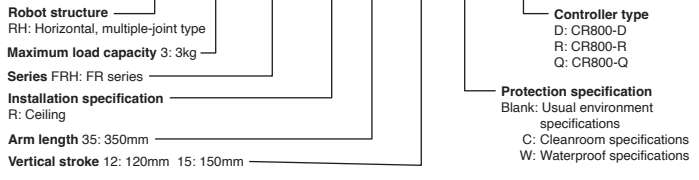

# MELFA Controller CR800-R/Q/D

CR800-R  
CR800-Q  
CR800-D

## MELSEC iQ-R/Q compatible robot controller

Uses a multi-CPU configuration that dramatically improves its interaction with FA equipment and also offers highly precise control and fast yet simple information management.

## Standalone type robot controller

Can be constructed as the control nucleus for robot controllers.



CR800-R



CR800-Q



CR800-D



## Specifications

Item	Unit	CR800-R	CR800-Q	CR800-D
Robot CPU		R16RTCPU	Q172DSRCPU	Built-in
Number of axes controlled		Maximum 6 axes + additional 8 axes available		
Robot language		MELFA-BASIC V, VI		
Position teaching method		Teaching method, MDI method		
Memory capacity	Number of teaching points	points	39000	26000
	Number of steps	step	78000	52000
	Number of programs	unit	512	
External input/output	General-purpose I/O	points	0 input/0 output (8192 input points/8192 output points with the multiple CPU common device)	
	Dedicated I/O	points	Assigned to multiple CPU common device	
	Gripper open/close	points	8 input / 8 output *6	
	Emergency stop input	points	1 (redundant)	
	Door switch input	points	1 (redundant)	
	Enabling device input *7	points	1 (redundant)	
	Emergency stop output	points	1 (redundant)	
	Mode output	points	1 (redundant)	
	Robot error output	points	1 (redundant)	
	Synchronization of additional axes	points	1 (redundant)	
Interface	Encoder input	channels	2	Q173DPX (optional)
	RS-422	ports	1 (dedicated T/B)	
	Ethernet	ports	1 (dedicated T/B)	
	USB *5	ports	1 (for customer) 10BASE-T/100BASE-TX/1000BASE-T Correspondence with CC-Link IE Field Basic (Ver.A1d or later)	
	Additional-axis function	channels	1 (Ver. 2.0 device functions only, mini B terminal)	
	Extension slot *1	slots	1 (SSCNET III/H)	
	R/C communication interface	channels	1 (Available only for function expansion option card)	
	Remote I/O	channels	2 (daisy chain)	
Power supply	Input voltage range *2	V	RV-2FR/4FR/7FR, RH-3FRH/3FRHR/6FRH/12FRH/20FRH: Single-phase AC 200V to 230V RV-13FR/20FR/7FRLL, RH-1FRHR: Three-phase AC 200V to 230V or Single-phase AC 230V	
	Power capacity *3	KVA	RV-2FR, RH-3FRH: 0.5 RH-3FRHR, RV-4FR, RH-6FRH: 1.0 RH-12FRH/20FRH: 1.5 RV-7FR (except RV-7FRLL): 2.0 RV-7FRLL, RV-13FR, RV-20FR: 3.0	
External dimensions (including legs)	mm	430(W) x 425(D) x 99.5(H)		
Mass	kg	Approx. 12.5		
Structure [protective specification]		Self-contained floor type/open structure (Vertical and horizontal position can be placed) [IP20]		
Grounding *4	Ω	100 or less (class D grounding)		

\*1: For installing option interface.

\*2: The rate of power-supply voltage fluctuation is within 10%.

\*3: The power capacity indicates the rating for normal operation. Take note that the power capacity does not include the inrush current when the power is turned on. The power capacity is only a rough guide and whether or not operation can be guaranteed depends on the input power-supply voltage.

\*4: Grounding works are the customer's responsibility.

\*5: Recommended USB cable (USB A-to-USB mini B): MR-J3USBCBL3M (Mitsubishi Electric), GT09-C30USB-5P (Mitsubishi Electric System & Service Co., Ltd)

\*6: RV-2FR series has 4 inputs and 4 outputs.

\*7: Mode selection switch provided by the customer.

## Controller

### CR800-R/CR800-Q

#### External Dimensions

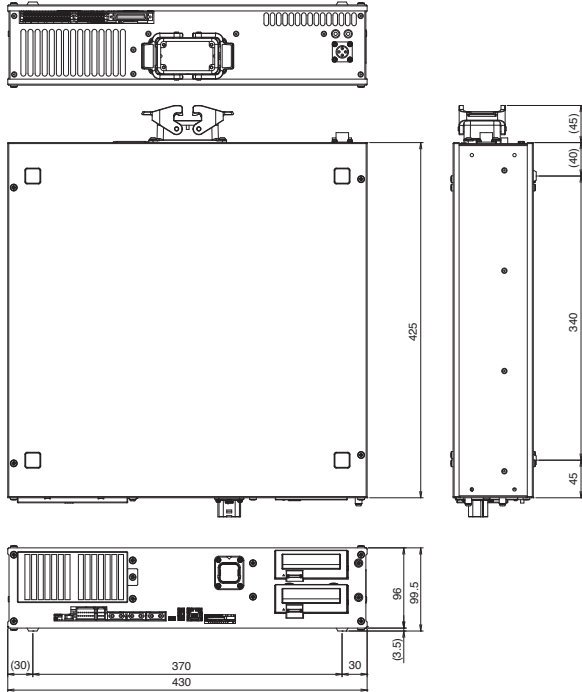

### CR800-D

#### External Dimensions

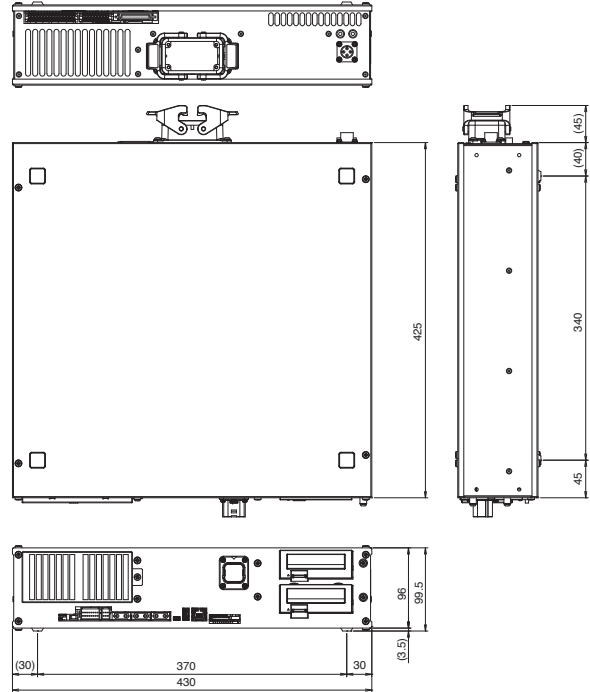

### R16RTCPU

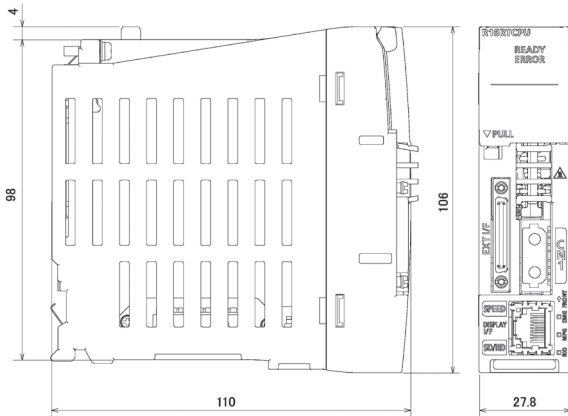

### Q172DSRCPU

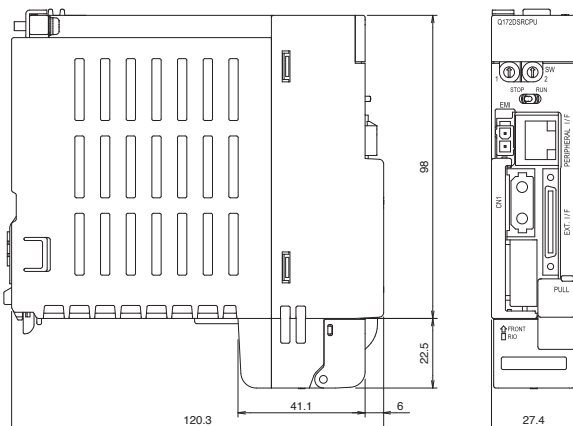

## Multiple CPU environment

#### <CR800-R>

Unit	Item
Base	R35B 5-slot
	R38B 8-slot
	R312B 12-slot
Power supply	R61P
	R62P
	R63P
	R64P
PLC CPU	R00CPU
	R01CPU
	R02CPU
	R04CPU
	R08CPU
	R16CPU
	R32CPU
	R120CPU
Safety CPU	R08SFCPU-SET
	R16SFCPU-SET
	R32SFCPU-SET
	R120SFCPU-SET

#### <CR800-Q>

Unit	Item
Base	High-speed standard base between multiple CPU
	Q35DB 5-slot
	Q38DB 8-slot
Power supply	Q312DB 12-slot
	Q61P
	Q62P
	Q63P
PLC CPU	Q64PN
	Universal Model
	Q03UD(E/V)CPU
	Q04UD(E/V)HCPU
	Q06UD(E/V)HCPU
	Q10UD(E)HCPU
	Q13UD(E/V)HCPU
	Q20UD(E)HCPU
Q26UD(E/V)HCPU	
Q100UD(E)HCPU	

Note) For details of the PLC units, refer to the PLC manual or the Mitsubishi Electric FA website, etc.

# MELFA Controller CR860-R/Q/D

CR860-R  
CR860-Q  
CR860-D

## MELSEC iQ-R/Q compatible robot controller

CR860-R/Q: Uses a multi-CPU configuration that dramatically improves its interaction with FA equipment and also offers highly precise control and fast yet simple information management.

CR860-D: Can be constructed as the control nucleus for robot controllers.



4

Controller Specifications

## ► Specifications

Item		Unit	CR860-R	CR860-Q	CR860-D
Robot CPU			R16RTCPU	Q172DSRCPU	Built-in
Number of axes			Maximum 6 axes + additional 8 axes available		
Programming language			MELFA-BASIC V,VI		
Position teaching method			Teaching or MDI		
Memory capacity	Number of teaching positions	point	39000	26000	39000
	Number of steps	step	78000	52000	78000
	Number of programs	point	512		
External input / output	General-purpose I/O	point	0 input / 0 output (8192 input / 8192 output with the multiple CPU common device)		0 input / 0 output (Up to 256 / 256 when options are used)
	Dedicated I/O	point	Assigned to multiple CPU common device		Assigned to general-purpose I/O
	Hand I/O	point	12 input points / 8 output points		
	External emergency stop input	point	1 (redundant)		
	Emergency stop output	point	1 (redundant)		
	Enabling device input	point	1 (redundant)		
	Mode output	point	1 (redundant)		
	Robot error output	point	1 (redundant)		
	Additional axis synchronization output	point	1 (redundant)		
	Door switch input	point	1 (redundant)		
Interface	Encoder input	point	2	Q173DPX (optional)	2
	Additional axis	channel	1 (SSCNET III/H)		
	Remote I/O	channel	1		
	USB	port	-		
	Ethernet	port	1 (Dedicated T/B) 1 (1000BASE-T / 100BASE-TX / 10BASE-T)		
	Option slot	slot	2 (Available only for function extension option card)		2
	SD memory card slot	slot	1 (Unusable)		1
	RS-422	port	1 (Dedicated T/B)		
Power supply	Emergency stop switch		1		
	Mode selector		1		
Power supply	Input voltage range	V	Three-phase 200 to 240 (The rate of power-supply voltage fluctuation is within +10% to -15%)		
	Power capacity	kVA	7.5 (Inrush current is not included)		
External dimensions		mm	670(W) × 500(D) × 670(H)		
Mass		kg	80		
Ambient temperature		°C	0 to 45 (Controller) / 0 to 55 (Robot CPU)		0 to 45
Ambient humidity		%RH	10 to 85		
Structure			Self-contained floor type, Enclose type IP54(FAN part : IP2X)		
Grounding		Ω	100Ω or less (Class D grounding)		



## Controller

### CR860-R/CR860-Q/R860-D

► External Dimensions

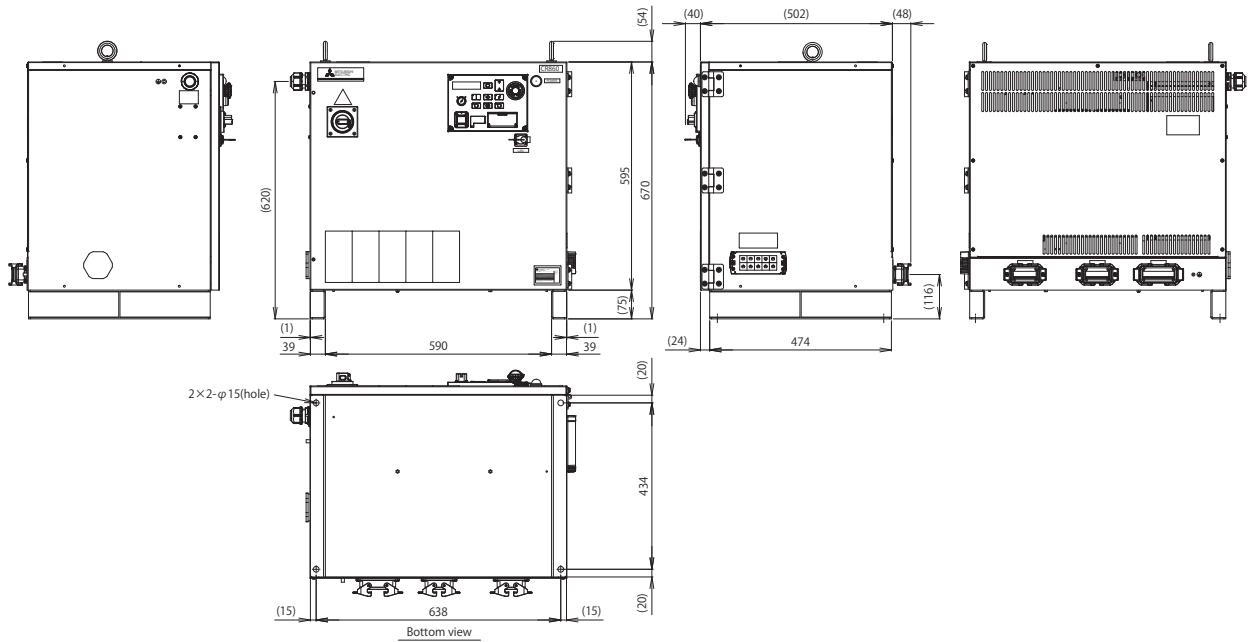

### Transformer unit(option)

By using this transformer unit, the robot can be operated with 400V power supply.

This transformer unit is used to step down the voltage from 400V to 200V. This transformer unit is designed only for the CR860 controller, and is not used for other controllers.

**Specification**

Item	Specifications
External dimensions	670(W) × 500(H) × 515(D)
Color	Dark gray
Mass	Approx. 120kg (only the robot arm, excluding cables)
Phase	Three-phase
Capacity	10kVA
Frequency	50Hz
Rated voltage (primary side)	AC420V(± 10%)
Rated voltage (secondary side)	AC210V(± 5%)
Wiring	Delta connection
Operating temperature	0 to 45°C
Relative humidity	10 to 85%RH
Elevation	1000m or lower
Protection specifications	IP54

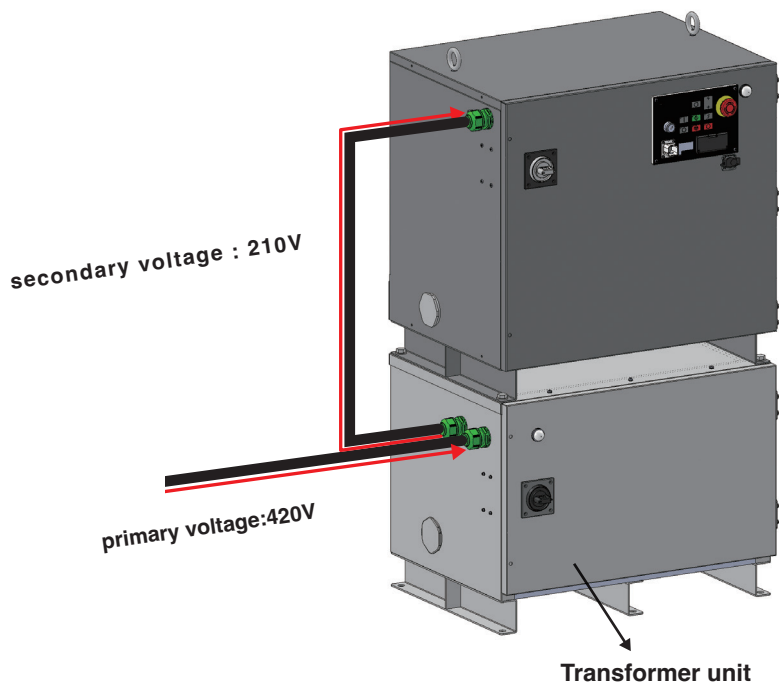

### Multiple CPU environment

► See P.54 details.

# OPTIONS

## Robot arm options(RV-FR series)

\* Excluding RV-35FR/50FR/80FR

5

Robot Option Specifications

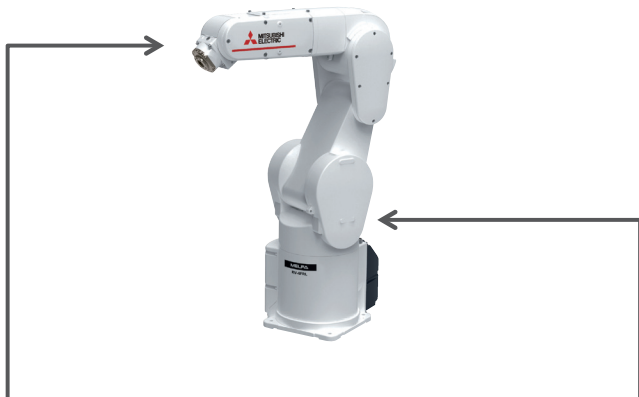

### ① Solenoid valve set (sink/source type)

With dedicated hand output cable  
1 to 4 valves



### ② Hand output cable

Used when solenoid valves are provided by the customer



### ③ Hand input cable

For gripper sensor signal input



### ④ Hand curl tube

Tube for pneumatic grippers (1 to 4 tubes)



### Machine cable (standard)

Fixed 5 m



### ⑦ Machine cable (replacement)

Fixed 2, 10, 15 or 20 m  
Flexible 10, 15 or 20 m



### J1 axis movement range modification

J2 axis movement range modification (RV-2FR series)

J3 axis movement range modification (RV-2FR series)

To be installed by the customer.

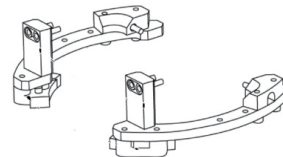

### Cable outlets in the machine

- Forearm external wiring set
- Base external wiring set

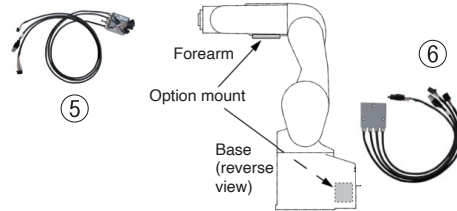

### Internal wiring/ tubing specifications

The factory default specification is for wiring/tubing to be routed internally to the wrist with an outlet from the mechanical interface.



# OPTIONS

## Robot arm options(RV-FR series)

No.	Name	Type	RV					Specifications
			2FR 2FRL	4FR 4FRL	7FR 7FRL	7FRLL	13FR 13FRL 20FR	
①	Solenoid valve set	1E-VD0m (sink) 1E-VD0mE (source)	○	—	—	—	—	1 to 2 valves with solenoid valve cable. m indicates the number of valves (1 or 2); output: Φ4
		1F-VD0m-02 (sink) 1F-VD0mE-02 (source)	—	○	○	○	—	1 to 4 valves with solenoid valve cable. m indicates the number of valves (1, 2, 3, 4); output: Φ4
		1F-VD0m-03 (sink) 1F-VD0mE-03 (source)	—	—	—	—	○	1 to 4 valves with solenoid valve cable. m indicates the number of valves (1, 2, 3, 4); output: Φ6
②	Hand output cable	1E-GR35S	○	—	—	—	—	Straight cable for 2-valve systems, robot connector on one end, unterminated on the other. Total length: 350 mm
		1F-GR35S-02	—	○	○	○	○	Straight cable for 4-valve systems, robot connector on one end, unterminated on the other. Total length: 500 mm
③	Hand input cable	1S-HC30C-11	○	—	—	—	—	4-point type, with a robot connector on one side and unterminated on the other.
		1F-HC35S-02	—	○	○	○	○	8-point type, with a robot connector on one side and unterminated on the other. Total length: 1000 mm
④	Hand curl tube	1E-ST040mC	○	○	○	○	—	For 1- to 4-Φ4-valve systems; total length: 630 mm (including 180 mm curled section) m indicates No. of tubes (2, 4, 6 or 8), 2 or 4 only in the RV-2FR and RV-2FRL
		1N-ST060mC	—	—	—	—	○	For 1- to 4-Φ6-valve systems; total length: 1150 mm (including 250 mm curled section) m indicates No. of tubes (2, 4, 6 or 8)
⑤	Forearm external wiring set 1	1F-HB01S-01	—	○	○	○	○	For the forearm. External wiring box used for connecting the gripper input cable, Ethernet cable and the electric gripper and force sensor cable.
	Forearm external wiring set 2	1F-HB02S-01	—	○	○	○	○	For the forearm. External wiring box used for connecting the force sensor, electric gripper and Ethernet cable.
⑥	Base external wiring set 1	1F-HA01S-01	—	○	○	○	○	For the base. External wiring box used for connecting the electric gripper communications output, electric gripper and force sensor cable and Ethernet cable. Includes gripper input.
	Base external wiring set 2	1F-HA02S-01	—	○	○	○	○	For the base. External wiring box used for connecting the electric gripper communications output, electric gripper, force sensor and Ethernet cable. No gripper input.
⑦	Machine cable (replacement) (fixed)	1F-mmUCBL-41	○	○	○	○	○	Replacement type, 2, 10, 15 or 20 mm mm indicates cable length (02, 10, 15 or 20 m)
	Machine cable (replacement) (flexible)	1F-mmLUCBL-41	○	○	○	○	○	Replacement type, 10, 15 or 20 mm mm indicates cable length (10, 15 or 20 m)
⑧	J1 axis movement range modification	1S-DH-11J1	○	—	—	—	—	Stopper for changing the range, installed by customer
		1F-DH-05J1	—	—	—	○	○	Stopper for changing the range, installed by customer (Also compatible with RV-7FRLL)
		1F-DH-04	—	—	○	—	—	Stopper for changing the range, installed by customer
		1F-DH-03	—	○	—	—	—	Stopper for changing the range, installed by customer
	J2 axis movement range modification	1S-DH-11J2	○	—	—	—	—	Stopper for changing the range, installed by customer
J3 axis movement range modification	1S-DH-11J3	○	—	—	—	—	Stopper for changing the range, installed by customer	

## RV-4FR/7FR/13FR/20FR series tooling machine configurations

The required options differ depending on the gripper (tool) configuration. The table below lists the "Forearm external wiring sets" and "Base external wiring sets" required for the different gripper configurations. Select wiring sets accordingly.

Gripper configuration	Wiring mode	Body specifications	Required equipment		Comment
			Forearm external wiring set	Base external wiring set (*3)	
•Pneumatic gripper + gripper input signals	Internal	-SH01	— (*1)	—	Air tubes: Up to 2 sets (Φ4 × 4), 8 input signals
	External	Standard	— (*2)	—	Air tubes: Up to 4 sets (Φ4 × 8)
•Pneumatic gripper + gripper input signals •Vision sensor	Internal	-SH05	— (*1)	(1F-HA01S-01)	Air tubes: Up to 1 set (Φ4 × 2), 8 input signals
	External	Standard	1F-HB01S-01 (*2)	1F-HA01S-01	Air tubes: Up to 4 sets (Φ4 × 8)
•Pneumatic gripper + gripper input signals •Force sensor	Internal	-SH04	— (*1)	(1F-HA01S-01)	Air tubes: Up to 1 set (Φ4 × 2), 8 input signals
	External	Standard	1F-HB01S-01 (*2)	1F-HA01S-01	Air tubes: Up to 4 sets (Φ4 × 8)
•Pneumatic gripper + gripper input signals •Vision sensor •Force sensor	Internal (External air tubes)	-SH02	— (*1)	(1F-HA01S-01)	External air tubes: Up to 4 sets (Φ4 × 8)
	External	Standard	1F-HB01S-01	1F-HA01S-01	Air tubes: Up to 4 sets (Φ4 × 8)
•Electric gripper + gripper input signals •Vision sensor	Internal	-SH02	—	(1F-HA01S-01)	
	External	Standard	1F-HB01S-01	1F-HA01S-01	
•Electric gripper •Vision sensor •Force sensor	Internal	-SH03	—	(1F-HA02S-01)	
	External	Standard	1F-HB02S-01	1F-HA02S-01	

\*1: For pneumatic grippers with internal wiring, solenoid valves should be provided.

\*2: For pneumatic grippers with external wiring, solenoid valves, tubing and input cables, etc. should be provided as necessary.

\*3: For machines with internal wiring and tubing, a base external wiring set is included with the machine and does not need to be provided separately.

# OPTIONS

## Robot arm options(RV-35FR/50FR/80FR)

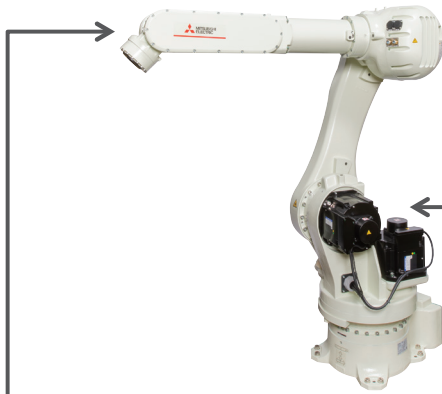

Machine cable (standard)

Fixed 7m



Machine cable (replacement) ④

Fixed 12,17or22m

Flexible 7,12,17 or 22m

Hand input cable ①

Cable for connection to hand open/close sensors,etc.



Hand output cable ②

Cable for connection to hand open/close sensors,etc.



Hand Ethernet cable ③

The customer should use this cable to connect a camera.



Operating range change stopper ⑤

The customer should install the optional stopper

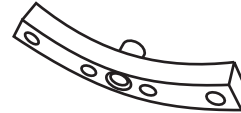

Breake releasing device ⑥

The brakes of the robot arm can be released without connecting a controller in emergency

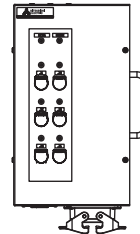

Power cable for the breake ⑦

This cable is used to connect between the breake releasing device and the robot arm and to supply brakepower to the robot.

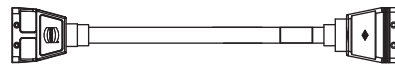

# OPTIONS

## Robot arm options(RV-35FR/50FR/80FR)

No.	Name	Type	Specifications
①	Hand input cable	1F-HC2000S-44	Robot side:Connector,Hand side:Wire (Input:12points,length:2,000mm)
②	Hand output cable	1F-GR2000S-44	Robot side:Connector,Hand side:Wire (Output:8points,length:2,000mm)
③	Hand Ethernet cable	1F-LAN2000-44	Robot side:Connector,Hand side:Wire (Total length:2,000mm)
④	Machine cable (replacement) (Fixed)	1F-□□UCBL-44	□□ in model name shows the cable length as follows, 12=12m,17=17m,22=22m
	Machine cable (replacement) (Flexible)	1F-□□LUCBL-44	□□ in model name shows the cable length as follows, 07=7m,12=12m,17=17m,22=22m
⑤	Operating range change stopper	1F-DH-44J1	J1 axis +side: +180 degrees, +160 degrees, +140 degrees, +120 degrees, +100 degrees, +80 degrees, +60 degrees, +40 degrees, +20 degrees -side: -180 degrees, -160 degrees, -140 degrees, -120 degrees, -100 degrees, -80 degrees, -60 degrees, -40 degrees, -20 degrees Two places can be selected from the above. The minimum operating range, however, is 80 degrees.
⑥	Brake releasing device	2F-BRKBOX-1	The brake of one axis (J1 to J6 axes) is released. The brakes of the J2 to J6 axes are intermittently released. Input power specifications:100 to 240V AC The customer needs to prepare an input power cable. Connect it to the robot arm using the machine cable (CN2). The power cable for the brake can be used for the connection.
⑦	Power cable for the brake	2F-BRKCBL-1	Cable length:5m

# OPTIONS

## Robot arm options(RH-FRH series)

5

Robot Option Specifications



### Solenoid valve set (sink/source type) ①

With dedicated hand output cable  
1 to 4 valves

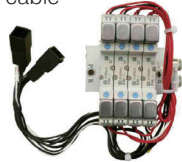

### Hand output cable ②

Used when solenoid valves are provided  
by the customer

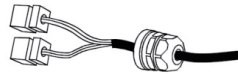

### Hand input cable ③

For gripper sensor signal input

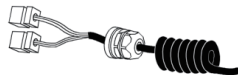

### Hand curl tube ④

Tube for pneumatic grippers (1 to 4 tubes)

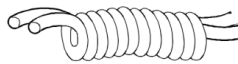

### Hand tube (for RH-3FRHR series) ⑤

Tube for pneumatic grippers (2 tubes)



### Machine cable (standard)

Fixed 5 m



### Machine cable (replacement) ⑧

Fixed 2, 10, 15 or 20 m  
Flexible 10, 15 or 20 m



### J1 axis movement range modification ⑨

J2 axis movement range modification  
To be installed by the customer.

### Internal wiring and tubing set for grippers ⑥

An air tube and cable set used to run air tubes  
and gripper input signal cables from inside  
the second arm to the shaft tip

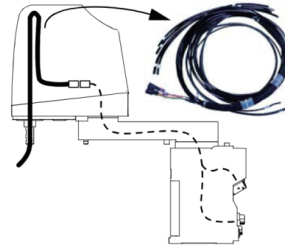

### External wiring and tubing box ⑦

A useful option for taking air tubes and signal  
wires out from the back end of the second arm or  
running gripper wiring and/or tubing outside the robot

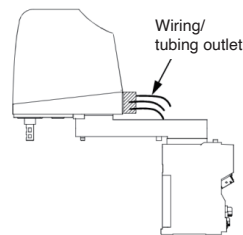

# OPTIONS

## Robot arm options(RH-FRH series)

No.	Name	Type	RH				Specifications
			3FRH	6FRH	12FRH 20FRH	3FRHR	
①	Solenoid valve set	1F-VD0m-01 (Sink) 1F-VD0mE-01 (Source)	○	○	—	—	1 to 4 valves with solenoid valve cable. □ indicates the number of valves (1, 2, 3, 4); output: Φ4
		1S-VD0m-01 (Sink) 1S-VD0mE-01 (Source)	—	—	○	—	1 to 4 valves with solenoid valve cable. □ indicates the number of valves (1, 2, 3, 4); output: Φ6
		1S-VD04-05 (Sink) 1S-VD04E-05 (Source)	—	—	—	○	4 valves with solenoid valve cable. output: Φ4 (standard)
		1S-VD04W-05 (Sink) 1S-VD04WE-05 (Source)	—	—	—	○	4 valves with solenoid valve cable. output: Φ4 (cleanroom specification / waterproof specification)
②	Hand output cable	1F-GR60S-01	○	○	○	—	For 4-valve systems, robot connector on one end, unterminated on the other, with drip-proof grommet Total length 1,050 mm, straight CBL
		1S-GR35S-02	—	—	—	○	Straight cable for 4-valve systems, robot connector on one end, unterminated on the other. Total length: 450 mm
③	Hand input cable	1F-HC35C-01	○	○	—	—	8-point type, with a robot connector on one side and unterminated on the other, equipped with a splash-proof grommet. Total length: 1650 mm (including 350 mm curled section)
		1F-HC35C-02	—	—	○	—	8-point type, with a robot connector on one side and unterminated on the other, equipped with a splash-proof grommet. Total length: 1800 mm (including 350 mm curled section)
		1S-HC00S-01	—	—	—	○	4-point type, with a robot connector on one side and unterminated on the other, equipped with a splash-proof grommet. Total length: 1210 mm
④	Hand curl tube	1E-ST0408C-300	○	○	—	—	For 4-Φ4-valve systems; total length: 1000 mm (including 300 mm curled section)
		1N-ST0608C-01	—	—	○	—	For 1- to 4-Φ6-valve systems; total length: 1300 mm (including 250 mm curled section)
⑤	Hand tube	1S-ST0304S	—	—	—	○	Φ3 for 2 valves (customer-usable length: 400 mm)
⑥	Internal wiring and tubing set for grippers	1F-HS604S-01	—	—	○	—	Internal wiring and tubing set for the tip axis (8 gripper inputs + Φ6 for two valves) For 350 mm Z-axis stroke
		1F-HS604S-02	—	—	○	—	Internal wiring and tubing set for the tip axis (8 gripper inputs + Φ6 for two valves) For 450 mm Z-axis stroke
		1F-HS408S-01	—	○	—	—	Internal wiring and tubing set for the tip axis (8 gripper inputs + Φ4 for four valves) For 200 mm Z-axis stroke
		1F-HS408S-02	—	○	—	—	Internal wiring and tubing set for the tip axis (8 gripper inputs + Φ4 for four valves) For 340 mm Z-axis stroke
		1F-HS304S-01	○	—	—	—	Wiring and piping set for internal mounting in the tip axis (compatible with 4 input points for gripper systems+Φ3-2 solenoid valve systems)
⑦	External user wiring and tubing box	1F-UT-BOX	○	○	—	—	External outlet box for user wiring (gripper input/output, gripper tubes)
		1F-UT-BOX-01	—	—	○	—	External outlet box for user wiring (gripper input/output, gripper tubes)
⑧	Machine cable (replacement) (fixed)	1F-mmUCBL-41	○	○	○	○	Replacement type, 2, 10, 15 or 20 m □□ indicates cable length (02, 10, 15 or 20 m)
	Machine cable (replacement) (flexible)	1F-mmLUCBL-41	○	○	○	○	Replacement type, 10, 15 or 20 m □□ indicates cable length (10, 15 or 20 m)
⑨	J1 axis movement range modification	1F-DH-02	—	—	○	—	Stopper for changing the range, installed by customer
		1F-DH-01	○	○	—	—	Stopper for changing the range, installed by customer
		1S-DH-05J1	—	—	—	○	Stopper for changing the range, installed by customer
	J2 axis movement range modification	1S-DH-11J2	—	—	—	—	Stopper for changing the range, installed by customer
		1S-DH-05J2	—	—	—	○	Stopper for changing the range, installed by customer

# SYSTEM

## CR800-R Controller

### System Configuration

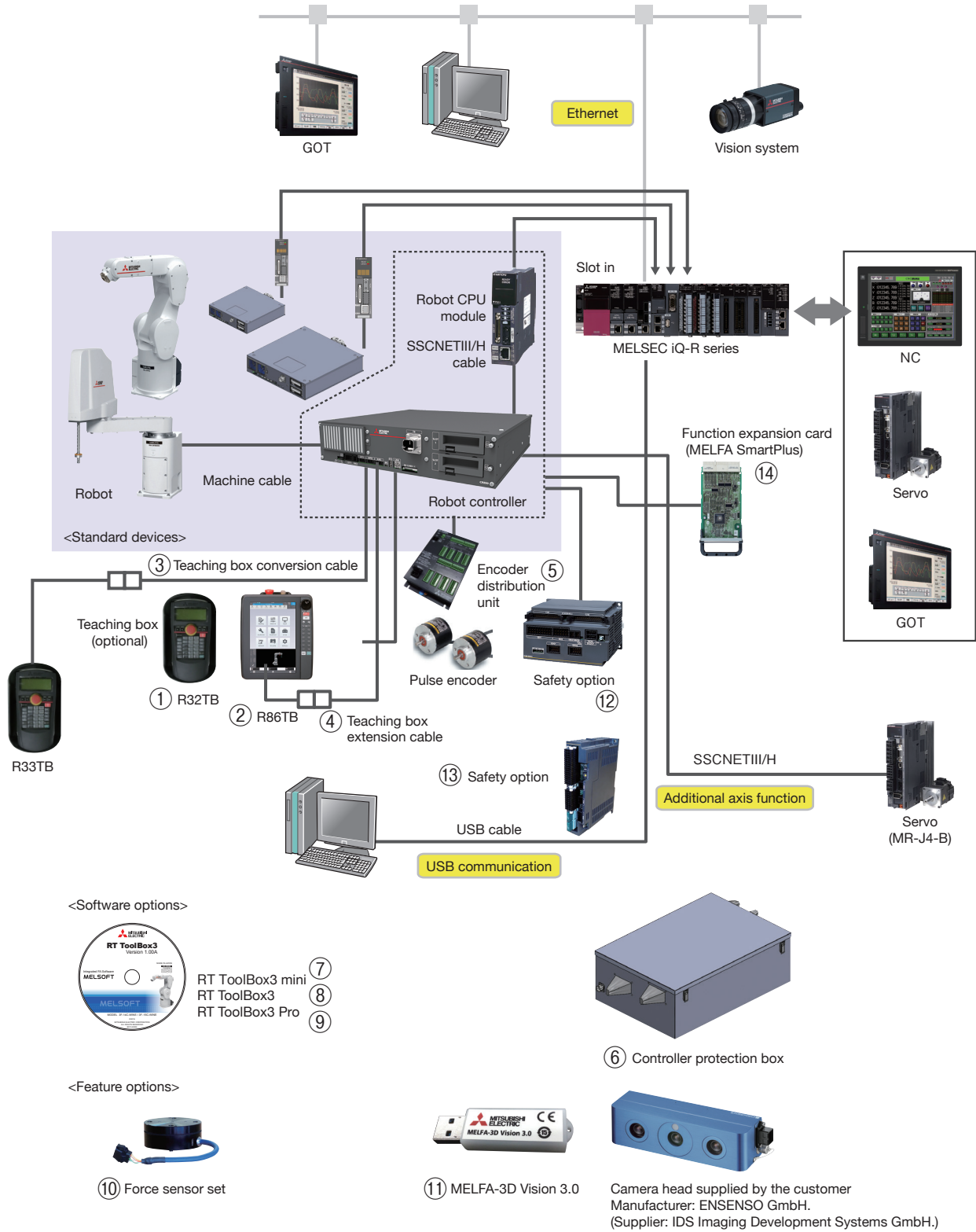



# OPTION (CR800-R Controller)

## Optional Configuration (Controllers)

No.	Name	Model	Specifications
①	Simple teaching box (7, 15 m)	R32TB (-**)	7 m: Standard; 15 m: Special (model name includes "-15")
②	High-performance teaching box(7m)	R86TB	7 m: Standard If 7 m is not enough, use a teaching box extension cable.
③	Teaching box conversion cable (33→32)	2F-33CON03M	Conversion cable for connecting the CR800 controller to the R33TB/R57TB. Cable length:3m
④	Teaching box extension cable	2F-32EXTBST-* *M	* * is the cable length. (01,05,10,15m)
⑤	Encoder distribution unit	2F-YZ581	Unit used for connecting multiple controllers to one rotary encoder when using the tracking function
⑥	Controller protection box	CR800-MB	Houses a controller and provides protection against dust and water. (IP54)
⑦	Computer support software mini version	3F-15C-WINE	Simplified version (DVD-ROM), (RT ToolBox3 mini)
⑧	Computer support software	3F-14C-WINE	With simulation function (DVD-ROM), (RT ToolBox3)
⑨	Computer support software Pro version	3F-16D-WINE	Professional version (DVD-ROM), (RT ToolBox3 Pro)

## Optional Configurations (Functions)

No.	Name	Model	Specifications
⑩	Force sensor set	4F-FS002H-W200	Set of devices required for force control functionality, including force sensors, the interface unit, and support software.
		4F-FS002H-W1000	
⑪	MELFA-3D Vision 3.0	3F-53U-WINM	MELFA-3D Vision software
⑫	Safety option	4F-SF002-01	Devices required by the safety functions
⑬	Safety option	4F-SF003-05	Devices required by the safety functions

## Option Configurations (Software Expansion Functions)

No.	Name	Model	Specifications
⑭	MELFA Smart Plus Card Pack	2F-DQ510	Enables all A-type functions
		2F-DQ520	Enables all A and B-type functions
	MELFA Smart Plus Card	2F-DQ511	Selects and enables one function from the A-type functions
		2F-DQ521	Selects and enables one function from the A and B-type functions

Classification	Name	Type	Function outline
Intelligent function	Calibration assistance function	A	Assists positional calibration with peripheral devices using 2D vision sensors.
	Automatic calibration		Improves positioning accuracy by automatically correcting the vision sensor coordinates.
	Work coordinate calibration		Improves positioning accuracy by correcting the robot coordinates and work coordinates from the vision sensor.
	Inter-robot relational calibration		Uses vision sensors to adjust the relative locations of multiple robots. Improves positioning accuracy during coordinated operation.
	2D vision sensor enhancement function	A	Various vision applications are used to facilitate vision alignment.
	Robot mechanism thermal compensation function	A	Improves positioning accuracy by compensating for thermal expansion in the robot arm.
	Coordinated control for additional axis	A	Function for highly accurate coordination (interpolation) with additional axis (straight coaxial)
AI function	Preventive maintenance function (Maintenance simulation, Wear calculation function)	A	Function for managing the robot status by tracking operation status. * Compatible with robot controller Version A3 or later.
	MELFA 3D Vision enhancement function	B	Automates 3D vision sensor parameter adjustment work, and improves measurement and recognition performance using AI technology. * Compatible with robot controller Version A3 or later.
	Predictive maintenance function (Fault detection function)	B	Quickly detects abnormalities in drive system components before they to affect robot behavior. * Compatible with robot controller Version A4 or later. * By enabling this function, it is also possible to use the preventive maintenance function (maintenance simulation and wear calculation function).
	Enhancement function for force sense control	B	Utilizes AI technology to perform repeated learning in a short time period to calculate the optimal insertion pattern. * Compatible with robot controller Version A4 or later.

# SYSTEM CR800-Q Controller

## System Configuration

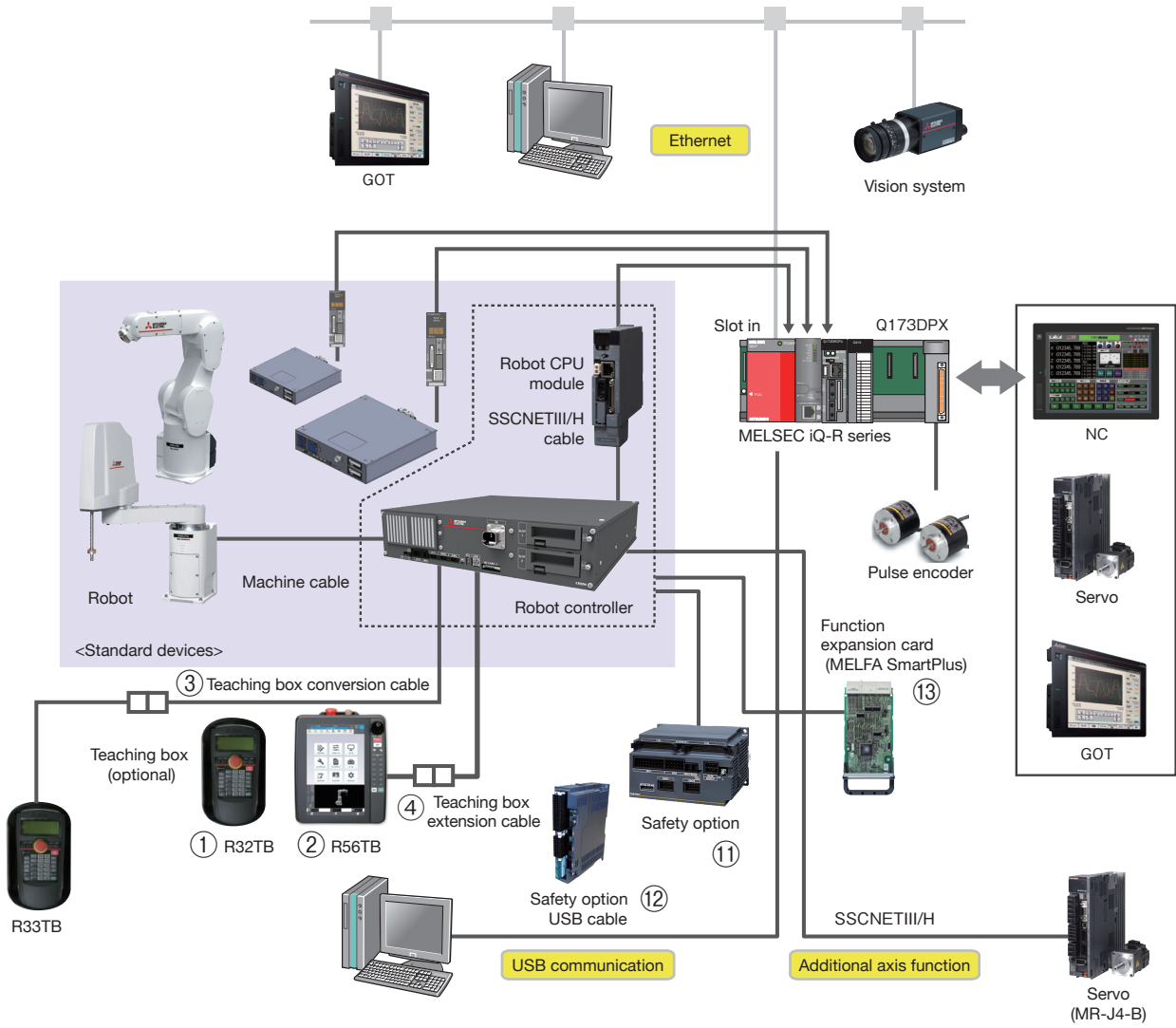

<Software options>



- RT ToolBox3 mini ⑥
- RT ToolBox3 ⑦
- RT ToolBox3 Pro ⑧

<Feature options>



- ⑨ Force sensor set



- ⑩ MELFA-3D Vision 3.0

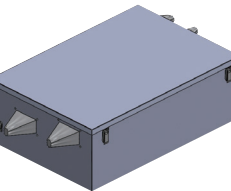

- ⑤ Controller protection box



Camera head supplied by the customer  
Manufacturer: ENSENSO GmbH.  
(Supplier: IDS Imaging Development Systems GmbH.)

# OPTION (CR800-Q Controller)

## Optional Configuration (Controllers)

No.	Name	Model	Specifications
①	Simple teaching box (7, 15 m)	R32TB (**)	7 m: Standard; 15 m: Special (model name includes "-15")
②	High-performance teaching box (7m)	R86TB	7 m: Standard if 7 m is not enough, use a teaching box extension cable.
③	Teaching box conversion cable (33→32)	2F-33CON03M	Conversion cable for connecting the CR800 controller to the R33TB/R57TB. Cable length:3m
④	Teaching box extension cable	2F-32EXTBST-***M	*** is the cable length.(01,05,10,15m)
⑤	Controller protection box	CR800-MB	Houses a controller and provides protection against dust and water. (IP54)
⑥	Computer support software mini version	3F-15C-WINE	Simplified version (DVD-ROM), (RT ToolBox3 mini)
⑦	Computer support software	3F-14C-WINE	With simulation function (DVD-ROM), (RT ToolBox3)
⑧	Computer support software Pro version	3F-16D-WINE	Professional version (DVD-ROM), (RT ToolBox3 Pro)

## Optional Configurations (Functions)

No.	Name	Model	Specifications
⑨	Force sensor set	4F-FS002H-W200	Set of devices required for force control functionality, including force sensors, the interface unit, and support software.
		4F-FS002H-W1000	
⑩	MELFA-3D Vision 3.0	3F-53U-WINM	MELFA-3D Vision software
⑪	Safety option	4F-SF003-05	Devices required by the safety functions
⑫	Safety option	4F-SF002-05	Devices required by the safety functions

## Option Configurations (Software Expansion Functions)

No.	Name	Model	Specifications
⑬	MELFA Smart Plus Card Pack	2F-DQ510	Enables all A-type functions
		2F-DQ520	Enables all A and B-type functions
	MELFA Smart Plus Card	2F-DQ511	Selects and enables one function from the A-type functions
		2F-DQ521	Selects and enables one function from the A and B-type functions

Classification	Name	Type	Function outline
Intelligent function	Calibration assistance function	A	Assists positional calibration with peripheral devices using 2D vision sensors.
	Automatic calibration		Improves positioning accuracy by automatically correcting the vision sensor coordinates.
	Work coordinate calibration		Improves positioning accuracy by correcting the robot coordinates and work coordinates from the vision sensor.
	Inter-robot relational calibration		Uses vision sensors to adjust the relative locations of multiple robots. Improves positioning accuracy during coordinated operation.
	2D vision sensor enhancement function	A	Various vision applications are used to facilitate vision alignment.
	Robot mechanism thermal compensation function	A	Improves positioning accuracy by compensating for thermal expansion in the robot arm.
	Coordinated control for additional axis	A	Function for highly accurate coordination (interpolation) with additional axis (straight coaxial)
AI function	Preventive maintenance function (Maintenance simulation, Wear calculation function)	A	Function for managing the robot status by tracking operation status. * Compatible with robot controller Version A3 or later.
	MELFA 3D Vision enhancement function	B	Automates 3D vision sensor parameter adjustment work, and improves measurement and recognition performance using AI technology. * Compatible with robot controller Version A3 or later.
	Predictive maintenance function (Fault detection function)	B	Quickly detects abnormalities in drive system components before they to affect robot behavior. * Compatible with robot controller Version A4 or later. * By enabling this function, it is also possible to use the preventive maintenance function (maintenance simulation and wear calculation function).
	Enhancement function for force sense control	B	Utilizes AI technology to perform repeated learning in a short time period to calculate the optimal insertion pattern. * Compatible with robot controller Version A4 or later.

# SYSTEM

## CR800-D Controller

### System Configuration

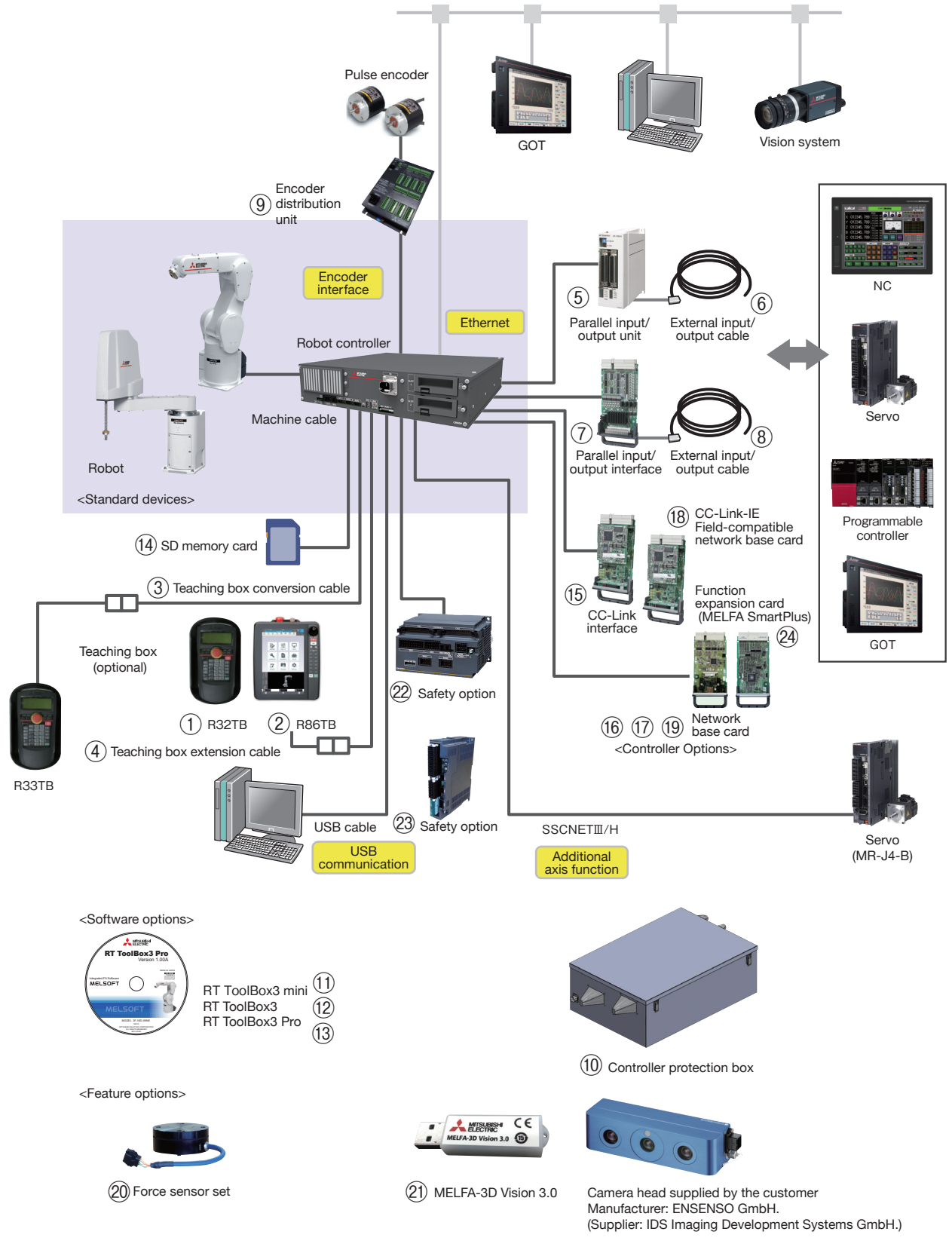

# OPTION (CR800-D Controller)

## Optional Configuration (Controllers)

No.	Name	Model	Specifications
①	Simple teaching box (7, 15 m)	R32TB (-**)	7 m: Standard; 15 m: Special (model name includes "-15")
②	High-performance teaching box (7m)	R86TB	7 m: Standard If 7m is not enough, use a teaching box extension cable
③	Teaching box conversion cable (33→32)	2F-33CON03M	Conversion cable for connecting the CR800 controller to the R33TB/R57TB. Cable length: 3m
④	Teaching box extension cable	2F-32EXTBST-***M	*** is the cable length. (01, 05, 10, 15m)
⑤	Parallel input/output unit	(Sink type)	2A-RZ361
		(Source type)	2A-RZ371
⑥	External input/output cable (5, 15 m)	2A-CBL**v	CBL05: 5 m; CBL15: 15 m, one end unterminated For 2A-RZ361/371
⑦	Parallel input/output interface (built-in)	(Sink type)	2D-TZ368
		(Source type)	2D-TZ378
⑧	External input/output cable (5, 15 m)	2D-CBL**	CBL05: 5 m; CBL15: 15 m, one end unterminated For 2D-TZ368/378
⑨	Encoder distribution unit	2F-YZ581	Unit used for connecting multiple controllers to one rotary encoder when using the tracking function
⑩	Controller protection box	CR800-MB	Houses a controller and provides protection against dust and water. (IP54)
⑪	Computer support software mini version	3F-15C-WINE	Simplified version (DVD-ROM), (RT ToolBox3 mini)
⑫	Computer support software	3F-14C-WINE	With simulation function (DVD-ROM), (RT ToolBox3)
⑬	Computer support software Pro version	3F-16D-WINE	Professional version (DVD-ROM), (RT ToolBox3 Pro)
⑭	SD memory card	2F-2GBSD	2 GB, logging
⑮	CC-Link interface	2D-TZ576	CC-Link intelligent device station Ver. 2.0, for 1-4 stations
⑯	Network base card (Ethernet/IP interface)	2D-TZ535	Communications interface for installation in an HMS Anybus-CompactCom module. HMS Ethernet/IP module (AB6314-B-218) to be provided by the customer.
⑰	Network base card (PROFINET interface)	2D-TZ535-PN	Communications interface for installation in an HMS Anybus-CompactCom module. HMS PROFINET IO module (AB6489-B) to be provided by the customer.
⑱	Network base card (CC-Link-IE Field interface)	2F-DQ535	Communications interface for installation in an HMS Anybus-CompactCom module. HMS CC-Link-IE Field module (AB6709-B-116) to be provided by the customer.
⑲	Network base card (EtherCAT interface)	2F-DQ535-EC	Communications interface for installation in an HMS Anybus-CompactCom module. HMS EtherCAT module (AB6607-D-224) to be provided by the customer.

## Optional Configurations (Functions)

No.	Name	Model	Specifications
⑳	Force sensor set	4F-FS002H-W200	Set of devices required for force control functionality, including force sensors, the interface unit, and support software.
		4F-FS002H-W1000	
㉑	MELFA-3D Vision 3.0	3F-53U-WINM	MELFA-3D Vision software
㉒	Safety option	4F-SF002-01	Devices required by the safety functions
㉓	Safety option	4F-SF003-05	Devices required by the safety functions

## Option Configurations (Software Expansion Functions)

No.	Name	Model	Specifications
㉔	MELFA Smart Plus Card Pack	2F-DQ510	Enables all A-type functions
		2F-DQ520	Enables all A and B-type functions
	MELFA Smart Plus Card	2F-DQ511	Selects and enables one function from the A-type functions
		2F-DQ521	Selects and enables one function from the A and B-type functions

Classification	Name	Type	Function outline
Intelligent function	Calibration assistance function	A	Assists positional calibration with peripheral devices using 2D vision sensors.
	Automatic calibration		Improves positioning accuracy by automatically correcting the vision sensor coordinates.
	Work coordinate calibration		Improves positioning accuracy by correcting the robot coordinates and work coordinates from the vision sensor.
	Inter-robot relational calibration		Uses vision sensors to adjust the relative locations of multiple robots. Improves positioning accuracy during coordinated operation.
	2D vision sensor enhancement function	A	Various vision applications are used to facilitate vision alignment.
	Robot mechanism thermal compensation function	A	Improves positioning accuracy by compensating for thermal expansion in the robot arm.
	Coordinated control for additional axis	A	Function for highly accurate coordination (interpolation) with additional axis (straight coaxial)
AI function	Preventive maintenance function (Maintenance simulation, Wear calculation function)	A	Function for managing the robot status by tracking operation status. * Compatible with robot controller Version A3 or later.
	MELFA 3D Vision enhancement function	B	Automates 3D vision sensor parameter adjustment work, and improves measurement and recognition performance using AI technology. * Compatible with robot controller Version A3 or later.
	Predictive maintenance function (Fault detection function)	B	Quickly detects abnormalities in drive system components before they to affect robot behavior. * Compatible with robot controller Version A4 or later. * By enabling this function, it is also possible to use the preventive maintenance function (maintenance simulation and wear calculation function).
	Enhancement function for force sense control	B	Utilizes AI technology to perform repeated learning in a short time period to calculate the optimal insertion pattern. * Compatible with robot controller Version A4 or later.

# SYSTEM

## CR860 Controller

### System Configuration

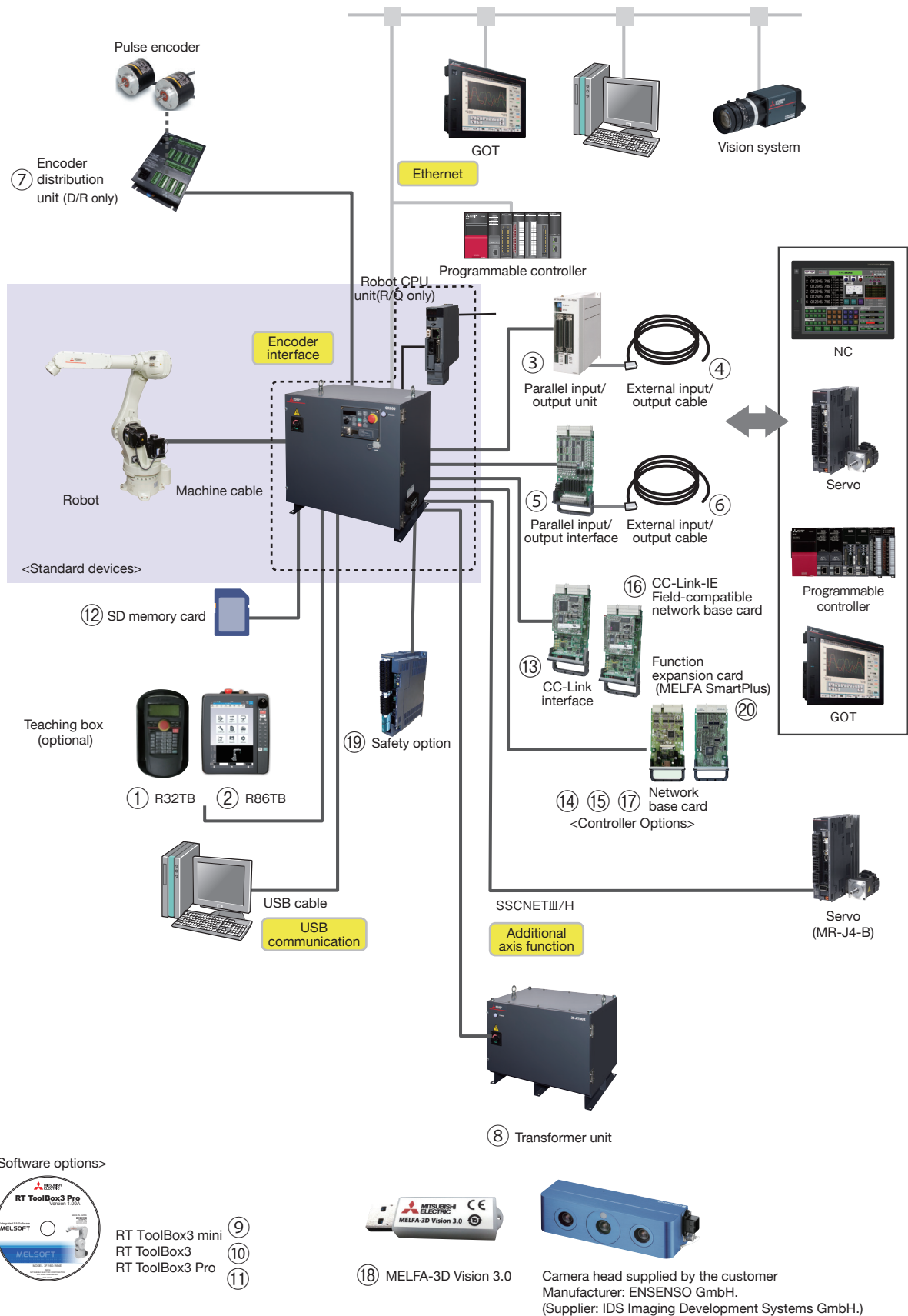

# OPTIONS (CR860 Controller)

## Optional Configuration (Controllers)

No.	Name	Model	Specifications
①	Simple teaching box (7, 15 m)	R32TB (-**)	7 m: Standard; 15 m: Special (model name includes "-15")
②	High-performance teaching box (7m)	R86TB	7 m: Standard
③	Parallel input/output unit	(Sink type) 2A-RZ361	32 outputs/32 inputs * Cannot be used with safety options.
		(Source type) 2A-RZ371	
④	External input/output cable (5, 15 m)	2A-CBL**v	CBL05: 5 m; CBL15: 15 m, one end unterminated For 2A-RZ361/371
⑤	Parallel input/output interface (built-in)	(Sink type) 2D-TZ368	32 outputs/32 inputs
		(Source type) 2D-TZ378	
⑥	External input/output cable (5, 15 m)	2D-CBL**	CBL05: 5 m; CBL15: 15 m, one end unterminated For 2D-TZ368/378
⑦	Encoder distribution unit	2F-YZ581	Unit used for connecting multiple controllers to one rotary encoder when using the tracking function (D/R only)
⑧	Transformer unit	2F-ATBOX	The robot can be used with a 400V power supply.
⑨	Computer support software mini version	3F-15C-WINE	Simplified version (DVD-ROM), (RT ToolBox3 mini)
⑩	Computer support software	3F-14C-WINE	With simulation function (DVD-ROM), (RT ToolBox3)
⑪	Computer support software Pro version	3F-16D-WINE	Professional version (DVD-ROM), (RT ToolBox3 Pro)
⑫	SD memory card	2F-2GBSD	2 GB, logging
⑬	CC-Link interface	2D-TZ576	CC-Link intelligent device station Ver. 2.0, for 1-4 stations
⑭	Network base card (Ethernet/IP interface)	2D-TZ535	Communications interface for installation in an HMS Anybus-CompactCom module. HMS Ethernet/IP module (AB6314-B-218) to be provided by the customer.
⑮	Network base card (PROFINET interface)	2D-TZ535-PN	Communications interface for installation in an HMS Anybus-CompactCom module. HMS PROFINET IO module (AB6489-B) to be provided by the customer.
⑯	Network base card (CC-Link-IE Field interface)	2F-DQ535	Communications interface for installation in an HMS Anybus-CompactCom module. HMS CC-Link-IE Field module(AB6709-B-116) to be provided by the customer.
⑰	Network base card (EtherCAT interface)	2F-DQ535-EC	Communications interface for installation in an HMS Anybus-CompactCom module. HMS EtherCAT module(AB6607-D-224) to be provided by the customer.

## Optional Configurations (Functions)

No.	Name	Model	Specifications
⑱	MELFA-3D Vision 3.0	3F-53U-WINM	MELFA-3D Vision software
⑲	Safety option	4F-SF003-05	Devices required by the safety functions

## Option Configurations (Software Expansion Functions)

No.	Name	Model	Specifications
⑳	MELFA Smart Plus Card Pack	2F-DQ510	Enables all A-type functions
		2F-DQ520	Enables all A and B-type functions
	MELFA Smart Plus Card	2F-DQ511	Selects and enables one function from the A-type functions
		2F-DQ521	Selects and enables one function from the A and B-type functions

Classification	Name	Type	Function outline
Intelligent function	Calibration assistance function	A	Assists positional calibration with peripheral devices using 2D vision sensors.
	Automatic calibration		Improves positioning accuracy by automatically correcting the vision sensor coordinates.
	Work coordinate calibration		Improves positioning accuracy by correcting the robot coordinates and work coordinates from the vision sensor.
	Inter-robot relational calibration		Uses vision sensors to adjust the relative locations of multiple robots. Improves positioning accuracy during coordinated operation.
	2D vision sensor enhancement function	A	Various vision applications are used to facilitate vision alignment.
AI function	Robot mechanism thermal compensation function	A	Improves positioning accuracy by compensating for thermal expansion in the robot arm.
	Coordinated control for additional axis	A	Function for highly accurate coordination (interpolation) with additional axis (straight coaxial)
	MELFA 3D Vision enhancement function	B	Automates 3D vision sensor parameter adjustment work, and improves measurement and recognition performance using AI technology. * Compatible with robot controller Version A3 or later.
AI function	Enhancement function for force sense control	B	Utilizes AI technology to perform repeated learning in a short time period to calculate the optimal insertion pattern. * Compatible with robot controller Version A4 or later.

# OPTIONS

## Solenoid valve set

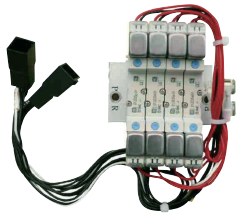

RH-3FRH and 6FRH  
RH-12FRH and 20FRH

When grippers or various other tools are mounted on the end of the arm, this solenoid valve option is used to control those tools. Fitted with features such as manifolds, couplings and connectors to facilitate mounting on the robot body. The solenoid valve attachment shapes differ depending on the robot. Note the attachment shape before using.

## Hand output cable

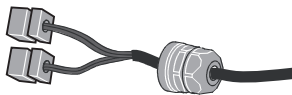

Cable size x No. of cores	AWG#24 (0.2 mm <sup>2</sup> ) x 12 cores
Total length:	300 mm (RV), 1050 mm (RH)

Useful for using solenoid valves other than the optional solenoid valve set. One end can be connected to the gripper signal output connector in the robot. The other end is unterminated (bare cable).

## Hand input cable

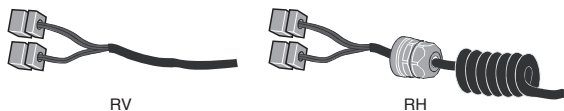

Cable size x No. of cores	AWG#24 (0.2 mm <sup>2</sup> ) x 12 cores
Total length:	1000 mm (RV), 1650/1800 mm (RH: Includes a 350 mm curled section)

Used when the air gripper is designed by the customer. Used to convey gripper open/close confirmation signals and grip confirmation signals to the controller. One end can be connected to the gripper signal input connector on the top of the robot body. The other end is connected to a sensor in the gripper designed by the customer.

## Hand curl tube

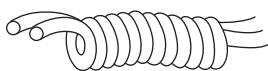

Material	Urethane
Size (mm)	Φ4 (external), Φ2.5 (internal); length: 180 mm curled section, 250 + 200 mm straight section

Curl tube for air gripper.

## Internal wiring and tubing set for grippers

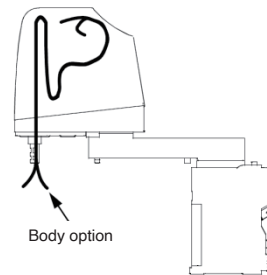

An air tube and cable set used to run input signal cables from inside the second arm to the shaft tip. An air tube and gripper input signal cable set. Includes grease (for applying to the upper part of the shaft), silicon rubber and cable ties.

## External user wiring and tubing box

This is a useful option for taking air tubes and signal wires out from the back end of the second arm or running gripper wiring and/or tubing outside the robot. Features a coupling for exiting air tubes and a hole with cable clamps to secure exiting signal wires. Optional gripper output cables and gripper input cables can be secured.

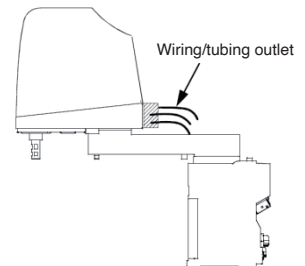

## J1 axis movement range modification

	RV (*1)	RH
+J1	(Standard +240°) +210°, +150°, +90°	(Standard +170°) +150°, +130°
-J1	(Standard -240°) -210°, -150°, -90°	(Standard -170°) -150°, -130°

\*1: For RV-2FR or RV-2FRL.  
Refer to the specifications for information on other models.

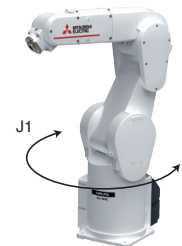

The J1 axis range of movement is limited by mechanical stoppers on the robot body and by the controller parameters. Use this feature when the range of movement needs to be limited due to problems such as interference with nearby devices.

## Machine cable (replacement)



Fixed cable	2m, 10m, 15m or 20m
Flexible cable	10, 15 or 20 m; min. bend radius: 100 R or more

Used for replacement of the standard machine cable (5 m) included to extend the distance between robot controller and the robot main unit and connect it. There are 2 types of cables: fixed and flexible. Both type consists of motor signal cable and motor power cable.



# OPTIONS

## Simple teaching box

### R32TB

External dimensions	195 (W) × 292 (H) × 106 (D) mm
Weight	Approx. 0.9 kg (body only, excluding cables)
Display	LCD type: 24 characters × 8 rows, backlit
Display languages	Japanese, English



Used for creating, editing and managing programs, to teach operating positions and for jogging. Fitted with a 3-position enabling switch to ensure safe use. When multiple robots are used, the connections can be switched to a single teaching box.

## High-performance teaching box

### R86TB

External dimensions	215 (W) × 284 (H) × 76 (D) mm
Weight	Approx. 1,200 g (cable not included)
Interface	USB host (Type-A) (32G bytes or less)
Display	10.1" TFT (800×1280) color touch panel with a back light
Display languages	Japanese/English/Simplified Chinese /Traditional Chinese



Easy to use, intuitive user interface, and key features of engineering software. We also provide data analysis methods for troubleshooting problems.

## Parallel input/output unit

### <Input>

Model	DC input	
No. of input	32	
Isolation method	Photocoupler isolation	
Rated input voltage	12 V DC	24 V DC
Rated input current	Approx. 3 mA	Approx. 7 mA

### <Output>

Model	Transistor output	
No. of outputs	32	
Isolation method	Photocoupler isolation	
Rated load voltage	12/24 V DC	
Maximum load current	0.1 A/output	



Used when external input/outputs are added. Connector cables for external devices are not included. External input/output cables (for parallel input/output units) are available as options. Both sink and source types are available. ※Cannot be used with safety option.

## Parallel input/output interface

### <Input>

Model	DC input	
No. of input	32	
Isolation method	Photocoupler isolation	
Rated input voltage	12 V DC	24 V DC
Rated input current	Approx. 3 mA	Approx. 9 mA

### <Output>

Model	Transistor output	
No. of outputs	32	
Isolation method	Photocoupler isolation	
Rated load voltage	12/24 V DC	
Maximum load current	0.1 A/output	



Installing this option on the controller allows external input/output to be used. Connector cables for external devices are not included. External input/output cables (for parallel input/output interfaces) are available as options. The input/output specifications are the same as for PLC interfaces. Both sink and source types are available.

## External input/output cables (for parallel input/output units)

Cable size × No. of cores	AWG#28 × 25P (50 cores)
Total length:	5 or 15 m



This is a dedicated cable for connecting external peripheral devices to parallel input/output unit connectors. One end is matched to the parallel input/output unit and the other end is unterminated. Input/output signals from peripheral devices should be connected via the unterminated end of the cable. One cable supports 16 inputs and 16 outputs. If a parallel input/output unit is installed, 32 inputs and 32 outputs are connected per unit, so two cables must be added.

## External input/output cables (for parallel input/output interfaces)

Cable size × No. of cores	AWG#28 × 20P (40 cores)
Total length:	5 or 15 m



This is a dedicated cable for connecting external peripheral devices to parallel input/output interface connectors. One end is matched to the parallel input/output interface and the other end is unterminated. Input/output signals from peripheral devices should be connected via the unterminated end of the cable. One cable supports 16 inputs and 16 outputs. If a parallel input/output interface is installed, 32 inputs and 32 outputs are connected per unit, so two cables must be added.

# OPTIONS

## CC Link Interface

Communication functions	Bit/word data transfer
Station type	Intelligent device station
Support station	Local station (no master station function)
CC-Link-compatible version	Ver.2, allows extended cyclic configuration
No. of isolated stations	Isolation of 1, 2, 3 or 4 stations can be configured



The CC-Link interface option augments CC-Link functionality by allowing cyclic transmission of word data as well as bit data to the robot controller.

## CC-LinkIE Field-compatible network base card

Installation module	AB6709-B-116
Transmission specifications	1Gbps (1000BASE-T)
No. of inputs	Max. 2,048
No. of outputs	Max. 2,048



CC-Link IE Field communication can be achieved by having the customer install an HMS Anybus-CompactCom module (order code: AB6709-B-116) in the network base card (2F-DQ535).

## EtherNet/IP-compatible network base card

Installation module	AB6314-B-218
Transmission specifications	10BASE-T/100BASE-TX
No. of inputs	Max. 2,048
No. of outputs	Max. 2,048



EtherNet/IP communication can be achieved by having the customer install an HMS Anybus-CompactCom module (order code: AB6314-B-218) in the network base card (2D-TZ535).

## PROFINET-compatible network base card

Installation module	AB6489-B
Transmission specifications	100BASE-TX
No. of inputs	Max. 2040
No. of outputs	Max. 2040



PROFINET IO communication can be achieved by having the customer install an HMS Anybus-CompactCom module (order code: AB6489-B) in the network base card (2D-TZ535-PN).

## EtherCAT-compatible network base card

Installation module	AB6707-D-224
Transmission specification	100Mbps (100BASE-TX)
No. of inputs	Bit device : Max. 256 points Word device: Max. 128 points
No. of outputs	Bit device : Max. 256 points Word device: Max. 128 points



EtherCAT communication can be achieved by having the customer install an Anybus-CompactCom module (order code: AB6707-D-224) in the network base card (2F-DQ535-EC).

## Safety option(4F-SF002-01)



Allows people to approach and enter the work area without stopping the robot.

Safety expansion unit	Input signal	8 systems (duplicated)
	Output signal	4 systems (duplicated)
	RIO cable	1m
	External dimensions	115 x 168 x 100mm
	Applicable robot controller	CR800-R/Q/D

## Controller protection box

Houses a controller and provides protection against dust and water. (IP54)

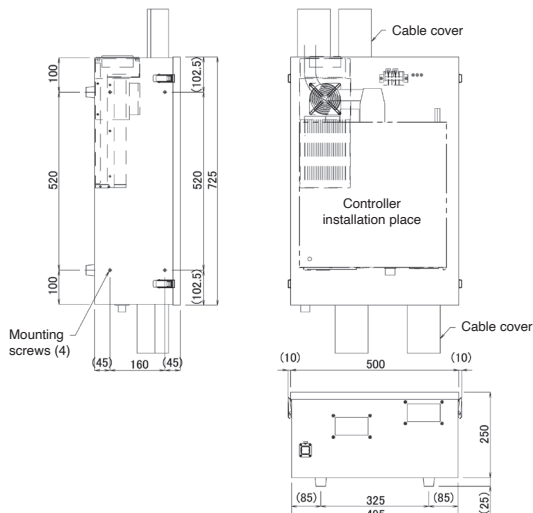

## Safety option(4F-SF003-05)



Allows people to approach and enter the work area without stopping the robot.

Safety expansion unit	Input signal	8 systems (duplicated)
	Output signal	4 systems (duplicated)
	RIO cable	5m
	External dimensions	40x174.5x115mm
	Applicable robot controller	CR800-R/Q/D(CR800-05VD excludes) CR860-R/Q/D

OPTIONS

# R86TB

Model R86TB

## Applicable to a wide range of work quickly

The R86TB is a new teaching box further evolved from the conventional high-performance teaching box. Even if a computer cannot be brought to the site, one teaching box can handle a series of processes from setup to maintenance, reducing time and cost.



**Improved operability**

Accessible from any screen

**Customizable**

Shortcut registration, user definition screens

**3D monitor incorporated**

Accessible from any screen

**Security function**

File editing can be restricted with a password, and use of functions can be restricted with user authority settings.

**Improved processing speed**

Stress-free operability

**Secure hardware buttons**

Tactile and consistent operation using physical buttons

Abundant information on the large screen display  
**10.1-inch** high-definition display

7  
Options

Features

Easy to operate, intuitive user interface

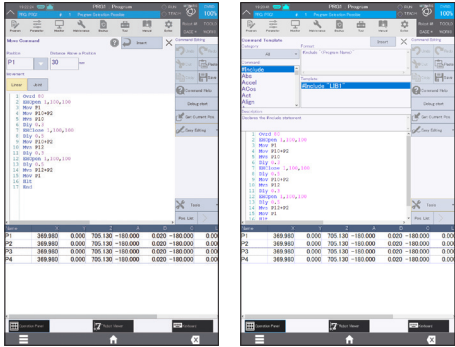

Any function can be accessed from the HOME screen or page list, and programs can be edited using the easy edit function and templates for further efficient setup.

Major functions of the engineering software incorporated

Various types of displays and analysis screens make it possible to perform trouble diagnosis and achieve early troubleshooting without a computer.

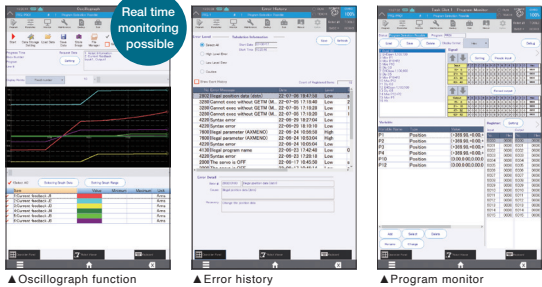
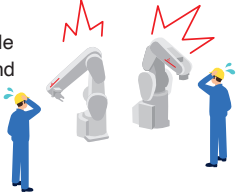

Data analysis ways provided for troubleshooting

Visualization of setting areas on the 3D monitor screen, settings of safety logic, monitoring of signals, variables, and load conditions, and more features can be utilized with just this one teaching box.

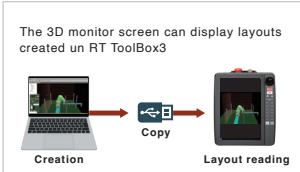
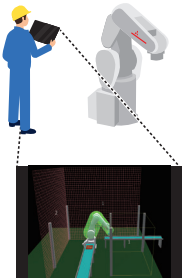

Monitoring functions equivalent to those of RT ToolBox3

Specification/function

Item	Specifications
External dimensions	215 (W) x 284 (H) x 76 (D) mm
Weight	Approx. 1,200g (only the teaching box, excluding cables)
Body color	Dark gray
Connection method	Connected with the controller using a dedicated connector, Cable length: 7m
Interface	USB port x1 (32G bytes or less)
Display	10.1TFT (800x1280) color touch panel with a back light
Operation section	Display (touch panel), emergency stop button, enable switch (3-position), wheel, operation-specific key x20
Display language	Japanese/English/Simplified Chinese/Traditional Chinese
Compatible controllers	CR800 series, CR700 series (Extension cable model: 2F-32EXTBST-□□ M (□□: 01, 05, 10, 15m)) CR751 (Conversion cable required, Conversion cable model: 2F-32CON□□ M (□□: 01, 05, 10, 15m))
Protection Level	IP65 (excluding conversion and extension cables, and the connector section)

# OPTIONS

# Force Sensor Set

Model 4F-FS002H-W200/1000

**Assembly/processing tasks are performed in the same manner as a human being, while sensing the force that is applied to the gripper. Tasks requiring subtle adjustment and detection of force can be performed.**

### Improved production stability

Parts can be inserted/attached without damage, while adjusting for displacement absorptions caused by parts variations and subtle external forces. Work stability is improved by position latching and retry processing at times of work failure. Furthermore, quality can be managed using log data, and the causes of work errors can be analyzed.

### Realization of complex assembly and processing tasks

Parts can be inserted/attached without damage, while adjusting for subtle external forces. Action direction and pushing force can be changed by detecting the contact force, and interrupt processing can be performed using trigger conditions that combine position information and force information.

### Easy control

Programs can be easily created using dedicated robot language. Based on representative examples of application programs, work programs can be easily created in response to each customer's required task.

### Simple operations

The robot can be quickly "taught" accurate positions based on position and force data from the teaching box. Work conditions can be verified and adjusted by viewing the position and force data from the teaching box and the graph waveform on RT ToolBox3.

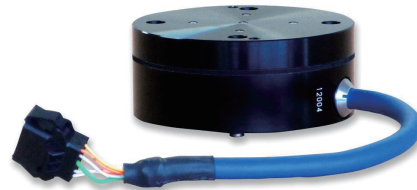

## Product features

Item		Features	
Controller	Force control	Force control	Function for controlling robots while applying a specified force
		Stiffness control	Function for controlling the stiffness of robot appendages
		Gain changes	Function for changing control characteristics while the robot is running
	Force detection	Execution of interrupts	Interrupts can be executed (MO triggers) under trigger conditions combining position and force information.
		Data latch	Function for acquiring force sensor and robot positions while contact made
		Data reference	Function for display force sensor data and maintaining maximum values
	Force log	Synchronous data	Function for acquiring force sensor information synchronized to position information as log data and displaying it in graph form
Start/stop trigger		Allows logging start/stop commands to be specified in robot programs	
FTP transmission		Function for transferring acquired log files to the FTP server	
Teaching box	Force sense control	Enables/disables force sensor control and sets control conditions while jogging.	
	Force sense monitor	Displays sensor data and the force sense control setting status.	
	Teaching position search	Function for searching for the contact position.	
	Parameter setting screen	Parameter setting screen dedicated for the force sense function. (For R56TB/R57TB)	

## System Configuration

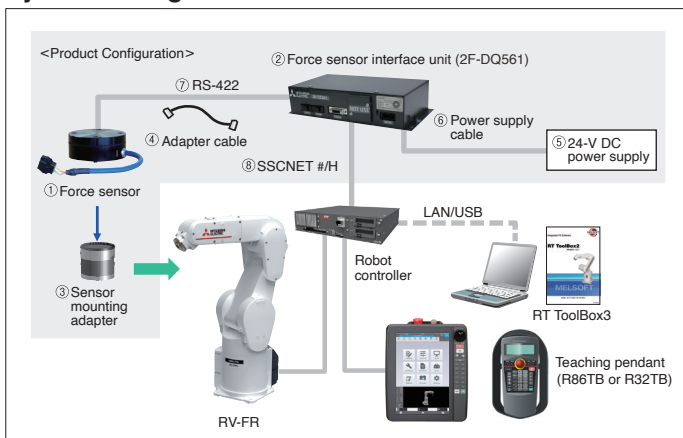

## Product Configuration

Name	Qty.	Name	Qty.
① Force sensor	Qty. 1	⑤ 24V DC power supply	Qty. 1
② Force sensor interface unit	Qty. 1	⑥ 24V DC power supply cable	1m
③ Sensor adapter (*1)	Qty. 1	⑦ Serial cable between the unit and sensor	5m
④ Adapter cable	Qty. 1	⑧ SSCNET III cable	10m

\*1 Not included in 4F-FS002H-W1000. An adapter needs to be selected from the chart at right and purchased separately in accordance with your robot model.

## Force Sensor Specifications

Item	Unit	Specification Value		
Rated load	-	4F-FS002H-W200	4F-FS002H-W1000	
Max. static load	Fx, Fy, Fz	N	200	1000
	Mx, My, Mz	Nm	4	30
Breaking load	Fx, Fy, Fz	N	0.3	
	Mx, My, Mz	Nm	0.03	
Consumption current	mA	200		
Weight (sensor unit)	g	360	580	
External dimensions	mm	Φ80×32.5	Φ90×40	
Protective structure	-	IP30		

## Force Sense Interface Unit Specifications

Item	Unit	Specification Value		
Interface	RS-422	ch	1 (For sensor connection)	
	SSCNET #/H	ch	1 (For robot controller and additional axis ampconnection)	
Power supply	Input voltage	Vdc	24±5%	
	Power consumption	W	25	
External dimensions	mm	225(W)×111(D)×48(H)		
Weight	kg	Approx. 0.8		
Construction	-	IP20 (Panel installation, opentype)		

## Sensor mounting adapter (for 4F-FS002H-W1000)

Name of product	Model
Sensor mounting adapter (for RV-2/4/7FR)	1F-FSFLGSET-01
Sensor mounting adapter (for RV-13/20FR)	1F-FSFLGSET-02

\* 4F-FS002H-W200 comes with a sensor mounting adapter (for RV-2/4/7FR).

OPTIONS

# MELFA-3D Vision 3.0

Model 3F-53U-WINM

Software for 3D vision sensors for small robots that deliver high-speed and high-accuracy measurements. The unique model-less recognition process allows bulk picking at a high speed.

**Compact and lightweight**

The compact and lightweight body (camera head: 175x52x50mm, 0.65 kg) can be used for hand-eye and fixed camera configurations. It can also be used in a mist environment due to its improved environmental resistance (IP65/IP67).

**Automatic calibration**

Equipped with an automatic calibration that automatically aligns the robot and vision sensor. This makes adjustments much easier.

**Automatic parameter setting with AI**

Mitsubishi's original AI technology and simulation technology automate the sensor parameter adjustment work, which requires expert knowledge. Anyone can easily achieve the same performance as a skilled worker in a short time without needing an actual machine. (Only when model-less recognition is used, compatible models: N35-804-16-IR, N35-806-16-IR, N35-808-16-IR)



MELFA-3D Vision 3.0  
(Manufactured by Mitsubishi Electric)

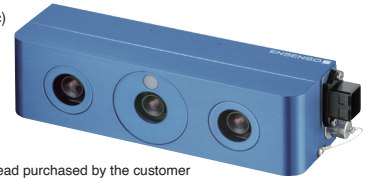

Camera head purchased by the customer  
Manufacturer: ENSENSO GmbH.  
(Supplier: IDS Imaging Development Systems GmbH.)  
For more details, please refer to the IDS website.  
<https://en.ids-imaging.com/ensenso-3d-camera-n-series.html>

**Product configuration**

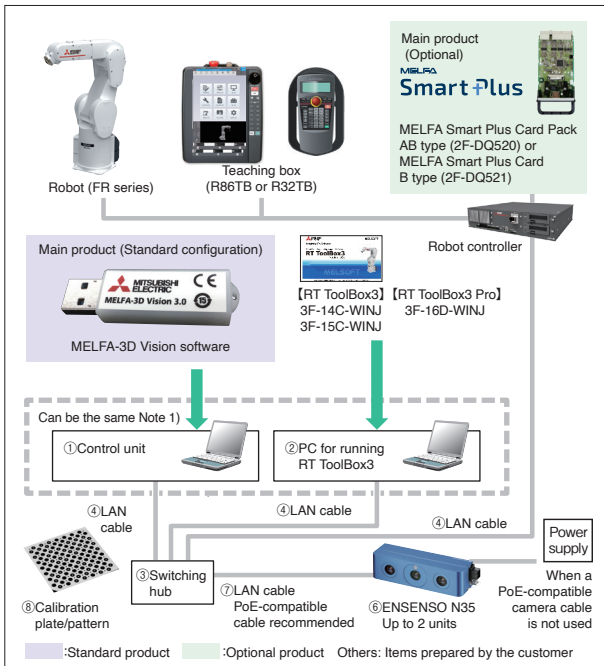

Name	Specifications	Quantity
① PC for running the MELFA-3D Vision 3.0 software	OS: Windows 10 Professional/ Enterprise (64bit) CPU: Intel Core i7 (9th generation) RAM: 8 [GB] or more HDD: 100 [GB] or more Gigabit Ethernet port x1	x1
② PC for running the RT ToolBox3	RT ToolBox3 installed (can be used with ①)	x1
③ Switching hub <sup>*1</sup>	1000BASE-T or higher, PoE-compatible	x1
④ LAN cable	Category 5e or higher	x3
⑤ Camera head mounting jig	—	x1
⑥ Camera head <sup>*2</sup>	ENSENSO N35 series (infrared model) See the table below. Manufacturer: ENSENSO GmbH. Supplier: IDS Imaging Development Systems GmbH.	x1
⑦ LAN cable <sup>*3</sup>	Category 5e or higher, PoE-compatible Recommended: AD00268 (Supplier: IDS Imaging Development Systems GmbH.)	x1
⑧ Calibration plate/pattern	Compatible with the camera head model selected in ⑥ Supplier: IDS Imaging Development Systems GmbH.	x1

\*1) The switching hub must be compatible with Gigabit Ethernet and PoE.  
If you do not use a PoE-compatible cable, you need to provide a separate camera power cable.  
\*2) There are also ENSENSO N35 series models other than those shown in the table below. For more details, please check with IDS Imaging Development Systems GmbH.  
\*3) A PoE-compatible LAN cable is recommended. If you do not use a PoE-compatible cable, you need to provide a separate camera power cable.

**Recommended models**

Model	N35-804-16-IR	N35-806-16-IR	N35-808-16-IR	N35-1204-16-IR	N35-1604-20-IR
Measurement range <sup>*1</sup> [mm]	388x291~ 860x645	287x215~ 435x326	231x173~ 290x217	315x236~ 431x323	248x186~ 268x201
Minimum workpiece size (reference)	Model-less: Short side of 1/25 of measurable area – long side of 1/3 of measurable area Model matching: Short side of 1/10 of measurable area – long side of 1/3 of measurable area				
Measurement time	Approx. 0.8 seconds				
Recognition time <sup>*2</sup>	Model-less: Approx. 0.5 seconds/Model matching: Approx. 1 second				
Work distance <sup>*3</sup>	480~1000	350~550	280~360	600~850	700~800
Focal length	650	420	310	700	750
External dimensions [mm]	W175xD52xH50				
Weight [kg]	0.65				
Usage environment [deg C]	0~45				
Protection Level	IP65/IP67				

\*1) This value is for when using MELFA-3D Vision 3.0. It may differ from the measurement range of the camera head.  
\*2) This is the standard time from the start of recognition to output. The process may take longer than the standard time depending on the conditions of the surrounding environment, workpieces, and processing parameters.  
\*3) The distance between the front end of the camera to the measurement point. All areas cannot be used at the same time.

**Workpiece distance and measurement range**

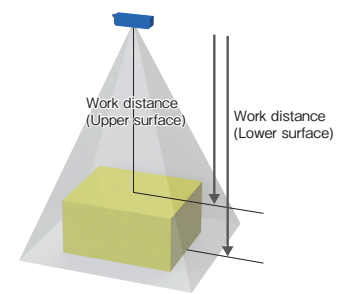

# RT ToolBox3/mini/Pro

## Software for program creation and total engineering support.

This is PC software that supports all processes from system startup to debugging and operations, including programming and editing, verification of the scope of operations prior to introducing a robot, estimation of tact time, robot debugging prior to startup, and monitoring of robot conditions and malfunctions during operations.

### Windows® compatible

- Easy operations on Windows®
- Compatible with Windows®10 (32bit, 64bit) and 11

### Simulation functions

- Compatible with all models that connect to the CRn-500 Series, CRn-700 Series, CR750 Series, and CR800 Series controllers.
- Robot movements and tact times can be calculated using a PC (not available with the mini version).
- Robot movements, operational status, input signals, and servo conditions can be monitored.

### Full support, from programming to startup and maintenance

- Programs can be edited using MELFA-BASIC IV, V and VI and (varies depending on the model).
- Robot movements, operational status, input signals, and servo conditions can be monitored.

### Enhanced maintenance functions

- Equipped with a maintenance forecast function that notifies users of the robot's greasing time and battery life, and an assistance function for position recovery in the event of trouble, the software is effective for preventive maintenance and for shortening recovery time.
- Data is managed by project, to allow collective backup of the entire system.

### Program editing and debugging functions

Programs are created using MELFA-BASIC IV, V and VI.<sup>\*1</sup> A multi-window format has been adopted for greater work efficiency and enhanced editing. Operations such as program step executions and breakpoint settings can be conveniently verified.

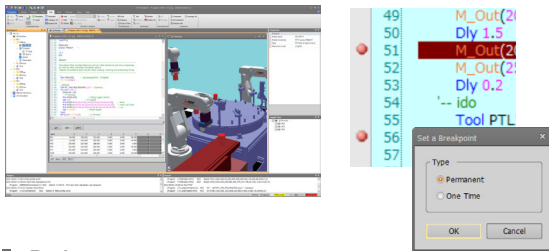

### 3D viewer

The 3D viewer allows easy verification of robot poses and movements, verification of the limit values of user-defined parameters, and virtual placements of peripheral devices by basic objects. It can also be used to check for interferences between the robot and peripheral devices. Distance measuring functions are also available on the screen.

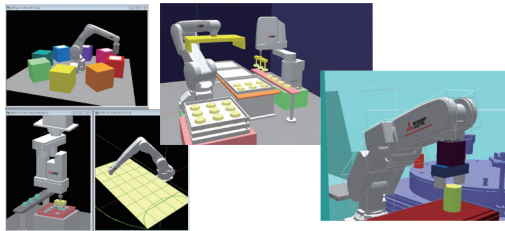

\*1: MELFA BASIC is a language that has been developed based on the usability and user-friendliness of the widely-used conventional BASIC language, with the addition of commands needed for robot control. MELFA BASIC IV/V not only offers these additional commands, but also incorporates structuring and parallel processing functions that were difficult to realize with BASIC, for even greater ease of use and detailed control.

#### <Example of a Pick & Place program>

Mov Psafe	Move to evasion point
Mov Pget,-50	Move above workpiece extraction position
Mvs Pget	Workpiece extraction position
Dly 0.2	Wait 0.2 seconds
Holose 1	Close hand
Dly 0.2	Wait 0.2 seconds
Mvs Pget,-50	Move above workpiece extraction position
Wait M_In (12)=1	Wait for signal
Mov Pput,-80	Move above workpiece placement position
Mvs Pput	Workpiece placement position
Dly 0.2	Wait 0.2 seconds
Hopen 1	Open hand
.....	

Classification	Main functions
Movements	Joint, linear, and circular interpolation, optimal acceleration/deceleration control, compliance control, collision detection, singular point passage
Input/output	Bit/byte/word signals, interrupt control
Numerical operations	Arithmetic calculation, pose (position), character strings, logic operations
Additional functions	Multi-tasking, tracking, vision sensor functions

### Simulation functions

Programs that have been created can be executed in the PC, movements can be verified, and the tact times of specified parts of a program can be measured. Such simulation functions are also effective for preliminary system examinations. Servo simulations can also be performed, for preliminary examination of loads. Signals can be coordinated with GX works2 and GX works3 for easy creation of line simulators. A maximum of 8 robots can be operated, and coordinated movements among robots can be verified.

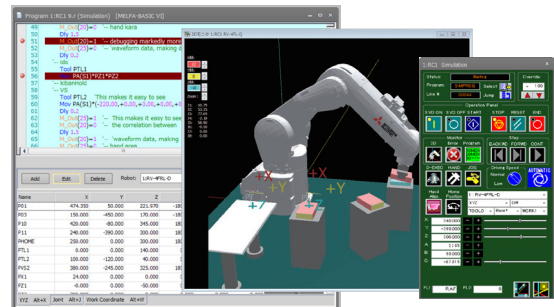

### Monitoring functions

Program execution status, variables, I/O signals, etc. can be monitored.

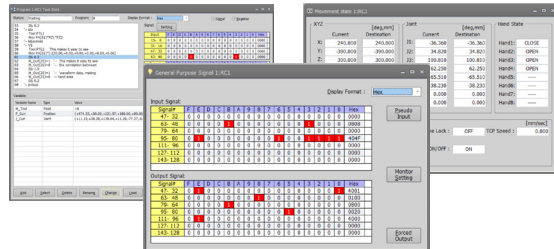

### Maintenance functions

Maintenance functions include maintenance forecasts, position recovery support, parameter management, etc.

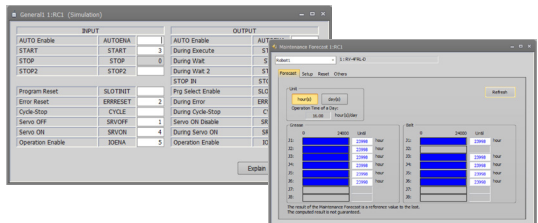

# OPTIONS

## Visual programming

RT ToolBox3 includes the visual programming function of RT VisualBox, which enables intuitive operations. It is easy to start up robots even without knowledge of robotics. It also supports simulation, allowing you to perform motion confirmation and interference checks of programs created with visual programming on a 3D layout.

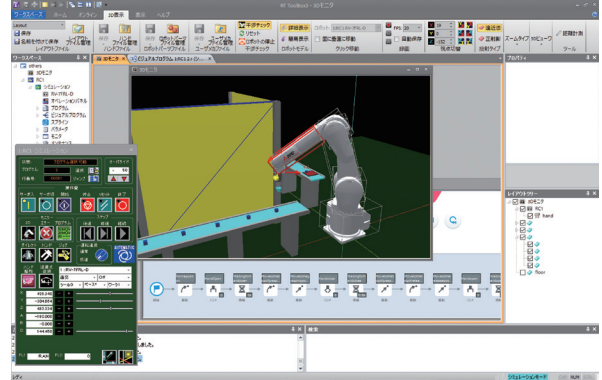
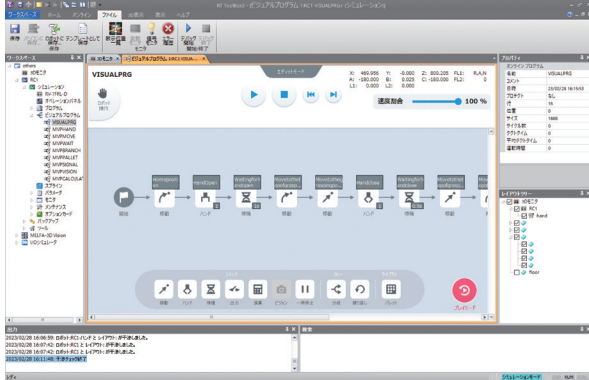

## MELFA Works

The MELFA Works function can be used in RT ToolBox3 Pro. MELFA Works, an add-in tool of SolidWorks, can simulate robot production systems on SolidWorks and output the data of processing paths on workpieces.

### CAD links

Work data for performing sealing operations and other such tasks that require many teaching steps can be easily created by selecting the processing area on the 3D CAD data. Since work data is created from 3D CAD data, even complex 3D curves can be generated, and the number of teaching steps can be significantly reduced.

### Simulation of robot operations

Robot programs, including I/O signals, can be simulated. That is, the operations of the actual system can be reproduced as they are. The I/O signals of a robot controller may be simulated according to two methods: (1) by defining movements associated with I/O signals in a simple manner, or (2) by linking robot programs with GX Simulator2/3

### Interference checks

Interferences between the robot and peripheral devices can be checked. Items that are to be subject to an interference check may be specified simply by clicking on it on screen. If an interference is detected, information about the interference (name of the part, the program line that was executed, the position of the robot when the interference occurred, etc.) may be stored in a log file.

### Calibration

The point sequence data of CAD coordinates created using CAD links is corrected into robot coordinate data, and the operation program and point sequence data are sent to the robot. In consideration of the frequent need for calibration onsite, the calibration tool is an application separate from SolidWorks®, designed to run efficiently on a laptop PC without SolidWorks® software.

### Cycle time

The cycle time of robot operations can be measured as if you are using a stopwatch. The cycle time of specified locations of a program can also be measured.

## Screen configuration

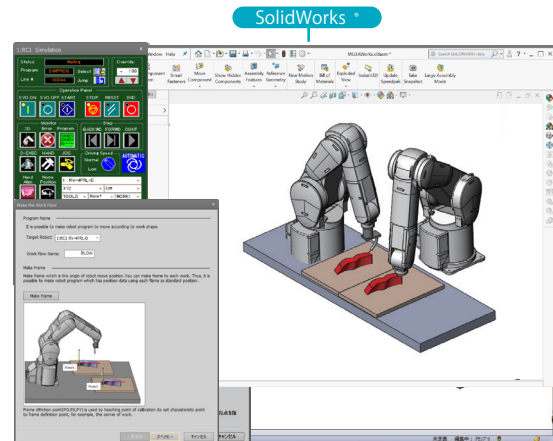

Calibration tool

Please contact your local representative or sales office.

## Multifunctional Electric Gripper Option

The multifunctional electric gripper option supports customer's various applications with various functions, great lineup, and highly accurate gripping

### Highly advanced control impossible with air cylinders

**Grip force/speed setting according to the target workpiece**

Grip patterns can be set according to the grip target, such as soft workpieces and heavy workpieces, with the torque specification and grip speed setting.

**Operation stroke setting according to the shape of the target workpiece**

Even when target workpieces are different in size, the optimal stroke can be specified with the operation position specification.

**Easily applied to inspection, in addition to workpiece handling**

Applications to inspection are possible with feedbacks of the torque or position of the gripper, including whether a workpiece is gripped or not or whether a workpiece is acceptable or not with workpiece dimension measurement.

### New applications will be available.

#### Components

	Name	Quantity	Remarks
1)	Electric gripper	1	Select the model by the grip force and stroke.
	Electric gripper control unit	1	Connected to the electric gripper.
2)	gripper cable	1	Connects the electric gripper and control unit.
	Robot cable	1	The cable type differs depending on the robot model.

#### Specifications of the electric gripper control unit

Item	Specifications	Remarks
External dimensions	60 (W) × 60 (D) × 40 (H)	
Weight	Approx. 200 g	
Input power source	24 V DC ±10%, 1 A (max.)	Powered by the robot controller (Customers need to prepare no power supplies.)
No. of teaching points	32 points	Position data for multiple-point position control

\* Only one model of the electric gripper control unit is available for the electric grippers.

(Note 1) To install the electric gripper to a mechanical interface, fabricate an attachment separately.

(Note 2) The cable of the electric gripper is not designed to be resistant to bending. Take cautions to prevent any stress from applying to the cable while the robot is operating.

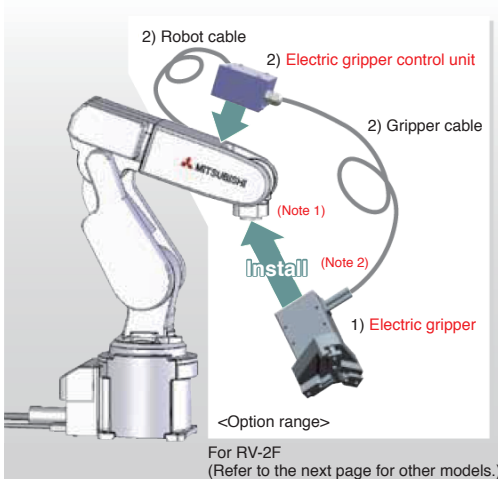

#### <Electric gripper>

Item	Specifications	Exterior image	
2-claw type (4 models)	Max. grip force	5.0 to 150N	
	Grip force adjustment range	100 to 30% of the max. grip force	
	Stroke	3.2 to 38mm	
	Max. speed	100mm/s(Screw type : 50mm/s)	
	Min. speed	20mm/s	
	Max. grip weight	0.05 to 1.5kg	
	Repetitive stop accuracy	±0.01 to 0.02mm	
Weight	90 to 890g		
3-claw type (1 model)	Max. grip force	2.0N	
	Grip force adjustment range	100 to 30% of the max. grip force	
	Stroke	13mm	
	Max. speed	100mm/s	
	Min. speed	20mm/s	
	Max. grip weight	0.02kg	
	Repetitive stop accuracy	±0.03mm	
Weight	190g		

Type	Model	Stroke(mm)	Grip force(N)	
2-claw type	Single-cam type	4F-MEHGR-01	3.2	1.5 to 5
		4F-MEHGR-02	7.6	1.8 to 6
		4F-MEHGR-03	14.3	6.6 to 22
	Screw type	4F-MEHGR-04	38	45 to 150
3-claw type	4F-MEHGR-05	13	0.6 to 2	



# OPTIONS

Please contact your local representative or sales office.

## Configuration requirement of the multi-function electric gripper

### RV-2FR series

No.	Name: model	Quantity	Purchased at	Remarks
1	Electric gripper	1	Mitsubishi Electric	Electric gripper used by customers
2	Control unit for the electric gripper: 4F-MEHCU-01	1	Mitsubishi Electric	
3	Electric gripper installation flange	1	Fabricated by customers	Electric gripper used by customers
4	Robot	1	Mitsubishi Electric	Standard specifications
5	Banding band/fixing plate	As required	Fabricated by customers	For fixing a cable

### RV-4FR/7FR/13FR/20FR series, external wiring specifications

No.	Name: model	Quantity	Purchased at	Remarks
1	Electric gripper	1	Mitsubishi Electric	Electric gripper used by customers
2	Control unit for the electric gripper: 4F-MEHCU-02	1		
3	Adapter cable: 4F-MEHCBL-01	1	Fabricated by customers	For fixing the tip of the electric gripper
4	Electric gripper installation flange	1		
5	Electric gripper control unit installation stand	1		
Robot				
6	Robot, standard (external wiring) specifications	1	Mitsubishi Electric	Standard specifications External wiring sets (option) need to be connected to each of the forearm part and base part.
7	External wiring unit for the base	1		1F-HA01S-01: When the gripper input signal and Ethernet signal are used together 1F-HA02S-01: When the force sensor signal and Ethernet signal are used together
8	External wiring unit for the forearm	1		1F-HB01S-01: When the gripper input signal and Ethernet signal are used together 1F-HB02S-01: When the force sensor signal and Ethernet signal are used together
9	Wrist wiring internal-wiring specifications: RV-□FR-SH02/SH03	1		Wrist wiring custom specifications SH02: When the gripper input signal and vision sensor signal are used together SH03: When the force sensor signal and vision sensor signal are used together

### RH-FR series

No.	Name: model	Quantity	Purchased at	Remarks	
1	Electric gripper	1	Mitsubishi Electric	Electric gripper used by customers	
2	Control unit for the electric gripper: 4F-MEHCU-02	1			
3	Relay cable	1			
	RH-3FRH35/45/5515 & C specifications Z=120 RH-6FRH(M)(C)35/45/5520	4F-MEHCBL-02 (Length: 1300 + 150 mm)			1
	RH-6FRH(M)(C)35/45/5534	4F-MEHCBL-03 (Length: 1600 + 150mm)			1
	RH-12FRH(M)(C)55/70/8535 RH-20FRH(M)(C)8535	4F-MEHCBL-04 (Length: 1800 + 150mm)	1		
4	Banding band, nylon clamp, etc.	1	Fabricated by customers	For fixing a cable	
	Electric gripper installation flange	1	Fabricated by customers	For fixing the shaft tip of the electric gripper	

### RV-4FR/7FR/13FR/20FR series, piping internal wiring specifications

Specifications	Possible gripper configuration	Accessory		Remarks
		External wiring set for the forearm	External wiring set for the base	
-SH02	•Electric gripper + gripper input signal •Vision sensor	-	1F-HA01S-01	An external wiring set for the base is enclosed with the internal wiring type robot.
-SH03	•Electric gripper •Vision sensor •Force sensor	-	1F-HA02S-01	

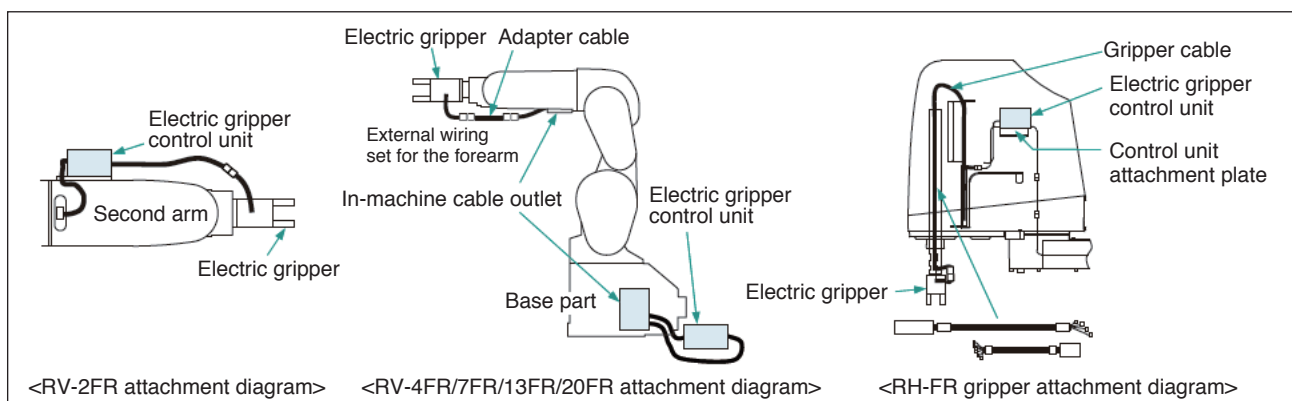

# WIRING SOLUTION

## ASLINK (Manufactured by AnyWire: Exclusively for Mitsubishi Electric robots)

The AnyWire ASLINK wiring system can be incorporated in MELFA robots, to resolve gripper wiring problems. By connecting the AnyWire dedicated cable unit to the standard wiring of a conventional robot, all 256 I/O points of the robot gripper can be used without drawing external wiring to the robot arm.

### By introducing AnyWire ASLINK...

**Before introduction**

**Issues:**

- Limited number of wires in multi-core cable
- Increased size due to relay box
- Increased weight
- Frequent stoppages due to disconnection

**After introduction**

**Improvements:**

- Larger number of points with fewer wires
- Elimination of relay box
- Conversion with easy additions and detachments
- Easy assembly using connector branches
- Reduced risk of disconnection with the use of internal cables

### MELFA × AnyWire ASLINK wiring/device calibration

No.	Device	Model	Quantity	Supplier	Remarks
①	Forearm external wiring set	1F-HB02S-01	1	Mitsubishi Electric	
②	Base external wiring set	1F-HA02S-01	1	Mitsubishi Electric	
③	AnyWire ASLINK unit	To be selected as required	n	AnyWire	
④	Forearm conversion adapter cable	BL2-RVAS	1	AnyWire	200mm fixed cable
⑤	Base conversion adapter cable	BL2-RVBS	1	AnyWire	200mm fixed cable
⑥	AnyWire ASLINK master unit	QJ51AW12AL	1	Mitsubishi Electric	For Mitsubishi Electric PLCs

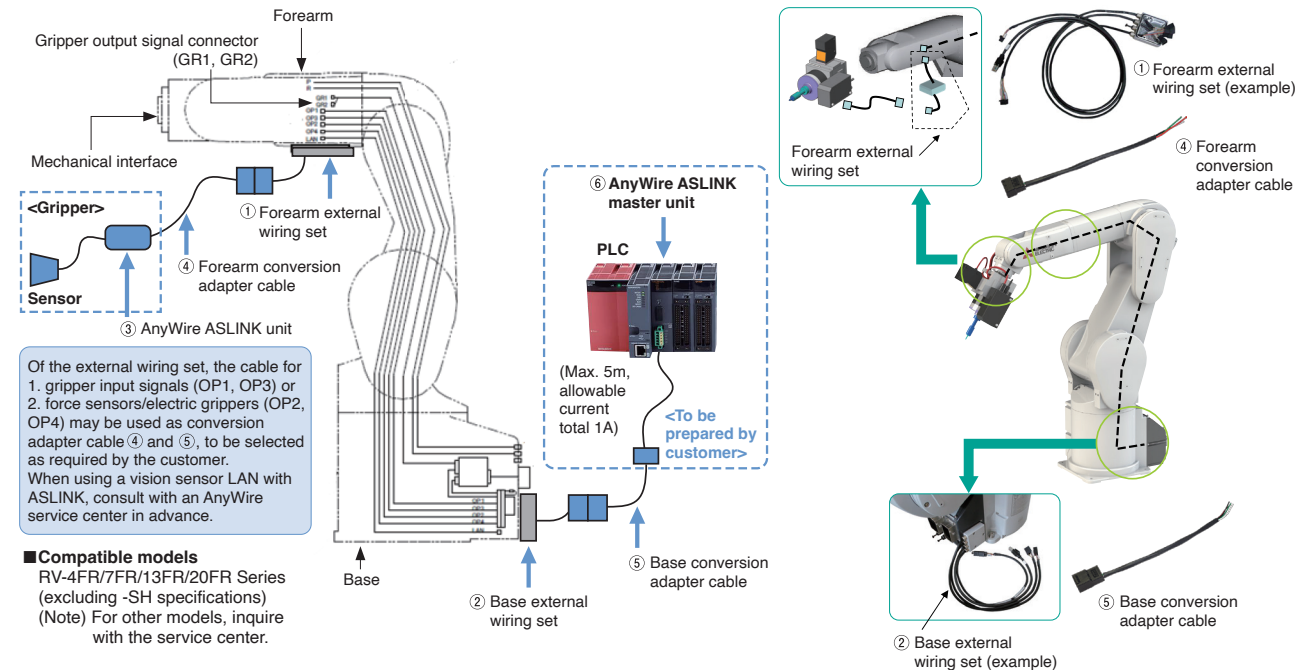

# TECHNICAL INFORMATION

## Calculating the Inertia

A tolerable inertia is set in the mechanical interface for robot arm. If a load exceeding this inertia is mounted, the robot may vibrate or an overload alarm may occur when the robot moves. When selecting the robot, it must be considered whether the hand or load to be mounted on the arm is suitable. The method of calculating the load inertia is explained below.

### Example 1 Horizontally articulated robot

Calculate the total inertia around the J4 axis.

$$I = I_{z_1} + I_{z_2} + W_1 L_1^2 + W_2 L_2^2$$

$I$  : Total inertia around the J4 axis  
 $I_z$  : Load inertia  
 $W$  : Each weight (kg)

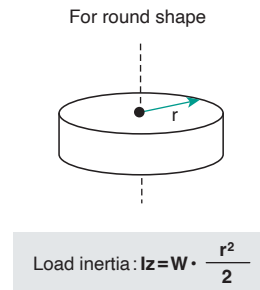
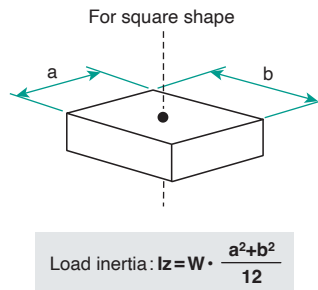
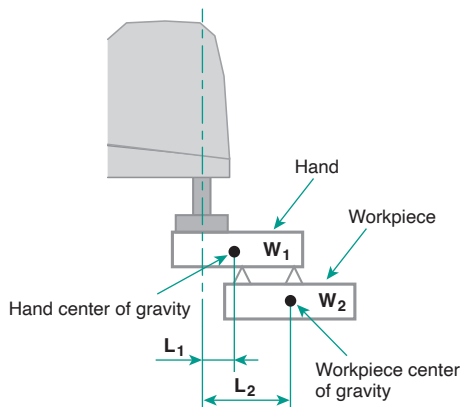

### [Example of calculation]

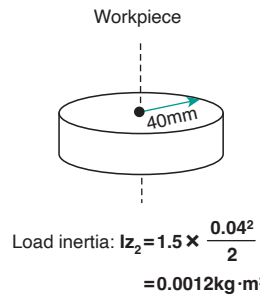
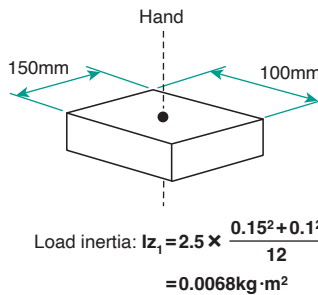
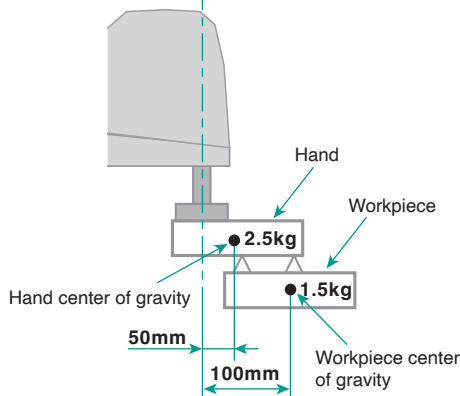

The total inertia around the J4 axis:

$$I = 0.0068 + 0.0012 + 2.5 \times 0.05^2 + 1.5 \times 0.1^2 = 0.030 \text{ kg} \cdot \text{m}^2$$

The RH-6FRH tolerable inertia (rating) is 0.01 kg·m<sup>2</sup> so 0.030 kg·m<sup>2</sup> exceeds the tolerable inertia.

However, if the hand center of gravity is aligned with the J4 rotary axis, and the workpiece is grasped directly below the J4 axis, both L<sub>1</sub> and L<sub>2</sub> become zero (0), so the total inertia around J4 axis can be determined by the following formula:

$$I = 0.0068 + 0.0012 = 0.008 \text{ kg} \cdot \text{m}^2 < 0.01 \text{ kg} \cdot \text{m}^2$$

This falls within the tolerable inertia.

Even if the total inertia is exceeded, consider changing the grasping method or changing the position.

# TECHNICAL INFORMATION

## Example 2 For vertically articulated robot

With the vertical articulated robot, the load moment for the wrist axis (J4 axis to J6 axis) and the load inertia for the wrist axis (J4 axis to J6 axis) must be reviewed. Consider the hand to be used and the posture of the workpiece, and calculate the load moment and load inertia applied on each of J4 axis to J6 axis. An example of the review is shown below.

### Example for calculating load moment (For J5 axis with flange facing downward)

Assume the following conditions as shown on the right:

Hand weight :  $W_1$  (kg)

Hand center of gravity position :  $L_1$  (m)

Workpiece weight :  $W_2$  (kg)

Workpiece center of gravity position :  $L_2$  (m)

In this case, the load moment applied on the J5 axis is determined as follows.

Where,  $g$ : gravitational acceleration (m/sec<sup>2</sup>).

J5 axis load moment (Nm):  $M = W_1 \times L_1 \times g + W_2 \times L_2 \times g$

Confirm that this value  $M$  falls within the tolerable moment of the model to be selected.

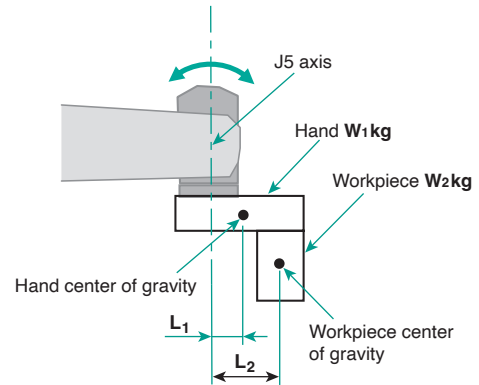

### Example of calculating load inertia (For J6 axis)

Assume the following conditions as shown on the right:

Hand weight :  $W_1$  (kg)

Distance from the J6 axis center to the hand center of gravity position :  $L_1$  (m)

Workpiece weight :  $W_2$  (kg)

Workpiece center of gravity position :  $L_2$  (m)

In this case, the load inertia applied on the J6 axis rotation is determined as follows.

The hand and workpiece shapes shall be square respectively, with dimensions of  $a_1 \times b_1$  and  $a_2 \times b_2$  respectively.

( $a$ : Vertical length,  $b$ : Horizontal length)

Load inertia around the hand J6 axis (kg·m<sup>2</sup>):

$$I_1 = I_{z1} + W_1 \times L_1^2 = W_1 \times (a_1^2 + b_1^2) / 12 + W_1 \times L_1^2$$

Load inertia around the workpiece J6 axis (kg·m<sup>2</sup>):

$$I_2 = I_{z2} + W_2 \times L_2^2 = W_2 \times (a_2^2 + b_2^2) / 12 + W_2 \times L_2^2$$

Load inertia around the J6 axis (kg·m<sup>2</sup>) based on the hand + workpiece:

$$I = I_1 + I_2$$

Confirm that this value falls within the tolerable inertia of the model to be selected.

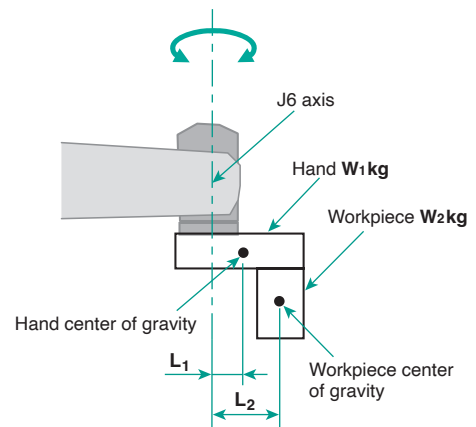

Note) If the posture change other than in the downward direction is large, the load moment around J4 axis must also be confirmed.

## Creating Solutions Together.



Low-voltage Power Distribution Products



Transformers, Med-voltage Distribution Products



Power Monitoring and Energy Saving Products



Power (UPS) and Environmental Products



Compact and Modular Controllers



Servos, Motors and Inverters



Visualization: HMIs



Edge Computing Products



Numerical Control (NC)



Collaborative and Industrial Robots

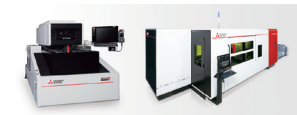

Processing machines: EDM, Lasers



SCADA

Our lineup of products ranges from controllers, drivers, and power management and energy-saving devices and also provides a flexible industrial network that connects each product line. Software and technology for data monitoring and controlling systems - such as SCADA, Cloud, and Edgex - together with worldwide IT/OT partners, we fully support system construction and operation. Mitsubishi Electric FA has everything to make IoT and Digital Manufacturing a reality.

With a complete portfolio and comprehensive capabilities that combine synergies with diverse business units, we will provide a one-stop approach to how companies tackle the shift to energy conservation, clean energy carbon neutrality, which is now required of factories, buildings, and social infrastructure.

We at Mitsubishi Electric FA are your solution partners who take a step toward the realization of sustainable manufacturing and society.

# Global Partner. Local Friend.

<b>USA</b> <b>Mitsubishi Electric Automation, Inc.</b> 500 Corporate Woods Parkway, Vernon Hills, IL 60061, U.S.A. TEL: +1-847-478-2100	<b>Brazil</b> <b>Mitsubishi Electric do Brazil Comercio e Servicos Ltda.</b> Avenida Adelino Cardana, 293, 21.o andar, Bethaville, Barueri SP, Brazil 06401-147 TEL: +55 (11) 4689-3003	<b>Mexico</b> <b>Mitsubishi Electric Automation, Inc. Mexico Branch</b> Boulevard Miguel de Cervantes Saavedra 301, Torre Norte Piso 5 Col. Ampliacion Granada, Miguel Hidalgo, Ciudad de Mexico, C.P.11520, Mexico TEL: +52(55)3067-7500
<b>Australia</b> <b>Mitsubishi Electric Australia Pty. Ltd</b> 348 Victoria Road, Rydalmere, NSW, 2116 Australia TEL: +61-2-9684-7777	<b>China</b> <b>Mitsubishi Electric Automation (China) Ltd.</b> No.1386 Hongqiao Road, Mitsubishi Electric Automation Center 3FShanghai, China TEL: +86-21-2322-3030	<b>Taiwan</b> <b>Mitsubishi Electric Taiwan Co., Ltd.</b> 10F, No.88 Sec. 6, Chung-Shan N.Rd,Taipei, Taiwan, TEL: +886-02-2833-5430
<b>Korea</b> <b>Mitsubishi Electric Automation Korea Co.,Ltd</b> 7F-9F, Gangseo Hangang Xi-lower A, 401, Yangcheon-ro, Gangseo-Gu, Seoul 157-801, Korea TEL: +82-2-3664-8333	<b>Singapore</b> <b>Mitsubishi Electric Asia Pte. Ltd</b> 307 Alexandra Road, Mitsubishi Electric Building, Singapore 159943 TEL: +65-6473-2486	<b>Malaysia</b> <b>MITSUBISHI ELECTRIC SALES MALAYSIA SDN. BHD.</b> Lot 11, Jalan 51A/219, Seksyen 51A, 46100 Petaling Jaya, Selangor Darul Ehsan, Malaysia +60-3-7626-5000
<b>Indonesia</b> <b>PT. Mitsubishi Electric Indonesia</b> Gedung Jaya 8th Floor, JL. MH. Thamrin No.12, Jakarta Pusat 10340, Indonesia TEL: +62-21-3192-6461	<b>Vietnam</b> <b>Mitsubishi Electric Vietnam Company Limited</b> 11th & 12th Floor, Viettel Tower B, 285 Cach Mang Thang Tam Street, Ward 12, District 10, Ho Chi Minh City, Vietnam. TEL: +84-28-3910-5945	<b>Thailand</b> <b>Mitsubishi Electric Factory Automation (Thailand) Co., Ltd.</b> 101, True Digital Park Office, 5th Floor, Sukhumvit Road, Bang Chak, Prakanong, Bangkok, Thailand TEL: +66-2092-8600
<b>Philippines</b> <b>MELCO Factory Automation Philippines Inc.</b> 128, Lopez-Rizal St. Brgy. Highway Hills, Mandaluyong City, MM, Philippines TEL: +63-(0)2-8256-8042	<b>India</b> <b>Mitsubishi Electric India Pvt. Ltd.</b> ICC-Devi Gaurav Technology Park, Unit no.402, Fourth Floor, Survey no. 191-192 (P) ,Opp, Vallabh Nagar Bus Depot, Pune - 411018, Maharashtra, India TEL:+91-(20)-46242100	<b>Germany</b> <b>Mitsubishi Electric Europe B.V.</b> <b>German Branch</b> Mitsubishi-Electric-Platz 1, 40882 Ratingen, Germany TEL: +49-2102-486-0
<b>UK</b> <b>Mitsubishi Electric Europe B.V.</b> <b>UK Branch</b> Travellers Lane, Hatfield, Hertfordshire, AL10 8XB, U.K TEL: +44 (0) 1707/28-87-80	<b>Italy</b> <b>Mitsubishi Electric Europe B.V.</b> <b>Italian Branch</b> Energy Park Via Energy Park 14, 20871, Vimercate (MB) TEL: +39-039-60531	<b>Spain</b> <b>Mitsubishi Electric Europe, B.V.</b> <b>Spanish Branch</b> Carretera de Rubi, 76-80-AC, 4720, E-08190 Sant Cugat del Valles (Barcelona), Spain TEL: +34-935-65-3131
<b>France</b> <b>Mitsubishi Electric Europe B.V.</b> <b>French Branch</b> 2, Rue de l'Union-92565 Rueil-Malmaison Cedex TEL: +33 (0) 1-55-68-57-01,	<b>Czech Republic</b> <b>Mitsubishi Electric Europe B.V.</b> <b>Czech Branch, Prague Office</b> Pekarska 621/7, 155 00 Praha 5, Czech Republic TEL: +420-734-402-587	<b>Poland</b> <b>Mitsubishi Electric Europe B.V.</b> <b>Polish Branch</b> ul. Krakowska 50, 32-083 Balice, Poland TEL: +48(0)12-347-65-00
<b>Ireland</b> <b>Mitsubishi Electric Europe B.V.</b> <b>Irish Branch</b> Westgate Business Park, Ballymount, IRL-Dublin 24 TEL: +353-14198800	<b>Netherland</b> <b>Mitsubishi Electric Europe B.V.</b> <b>Netherlands Branch</b> Capronilaan 46, NL-1119 NS Schiphol-Rijk TEL: +31-297-250-350	<b>Hungary</b> <b>Mitsubishi Electric Europe B.V.</b> <b>Hungarian Branch</b> 2040 Budaors, Szabadsag ut 117 TEL: +36-70-3322-372
<b>Sweden</b> <b>Mitsubishi Electric Europe B.V.</b> <b>Sweden Branch</b> Hedvig Mollers gata 6 223 55 Lund TEL: +46(0)8-625-10-84	<b>Turkey</b> <b>Mitsubishi Electric Europe B.V.</b> <b>Turkey Branch</b> Serifali Mahallesi. Kale Sok. No.41, 34775 Umraniye / ISTANBUL TEL: +90(0)216/969-25-00	<b>India</b> <b>MITSUBISHI ELECTRIC INDIA PRIVATE LIMITED</b> ICC Devi Gaurav Technology park, Unit no 4+B12:D2902 4th floor, Pimpri Pune -411018 Maharashtra India TEL: +91-020-46242227

Windows is registered trademark of Microsoft Corporation in the United States and other countries.

Ethernet is registered trademark of Xerox Corporation.

SolidWorks is trademark of Dassault Systèmes SolidWorks Corporation.

All other company names and product names used in this document are trademarks or registered trademarks of their respective companies.

**MITSUBISHI ELECTRIC CORPORATION**

HEAD OFFICE: TOKYO BLDG., 2-7-3 MARUNOUCHI,  
CHIYODA-KU, TOKYO 100-8310, JAPAN